



FILTRATION AND PARTICLE ANALYSER HANDBOOK

MANUAL
OF ANALYSIS



EN

PASSION  PERFORM



	page
Introduction	2
Sampling Procedures	4
Methods of taking samples from hydraulic applications using appropriate sample containers (standard ISO 3722)	4
Contamination Reporting Formats	6
NAS 1638 Contamination classification standard	6
SAE AS4059G Contamination classification for hydraulic fluids (SAE Aerospace Standard)	7
ISO 4405 Gravimetric level	9
ISO 4406 Contamination code system	9
Recommended Contamination Classes	11
Contaminant Sizes	12
ISO 4407 Cumulative distribution of the particles size	12
Comparison Photographs	13
Hydraulic System Target Cleanliness Levels	16
Standards cleanliness code comparison	16
Viscosity Conversion Chart	17
Introduction to Particle Monitoring	18
Introduction to particle monitoring	18
A little contamination goes a long way	18
The scale of the problem	18
The importance of preventive cleanliness maintenance	19
Key requirements for a fluid contamination monitor	19
How Contamination Monitoring Products Work	20
Product CMP	20
Technology - LED	21
The flushing process	21
The analysis process	22
Technology - TWIN-LASER	22

TABLE OF CONTENTS

Calibration Procedures and Test dust	page 24
Hydraulic Filtration Products	25
Filter Sizing Calculation	26
Filter Element Beta Ratio Information	28
Filter Beta ratios	28
Reynolds Numbers	29
Technical informations	29
Flushing information for various pipe diameters	29
Water in Hydraulic and Lubricating Fluids	30
Water content	30
Saturation levels	30
Water absorber	31
Fluid Compatibility Tables	32



THE COMPLETE MP FILTRI PRODUCT RANGE

In hydraulic fluid power systems, power is transmitted and controlled through a liquid under pressure within an enclosed circuit. The liquid is both a lubricant and a power transmitting medium.

The presence of solid contaminant particles in the liquid inhibits the ability of the hydraulic fluid to lubricate and causes wear to the components. The extent of contamination in the fluid has a direct bearing on the performance and reliability of the system and **it is necessary to control solid contaminant particles to levels that are considered appropriate for the system concerned.**

A quantitative determination of particulate contamination requires precision in obtaining the sample and in determining the extent of contamination. **MP Filtri's range of Contamination Monitoring Products (CMP)**, work on the light-extinction principle. This has become an accepted means of determining the extent of contamination.



...because contamination costs!

70–80% of all failures
on hydraulic systems and up to 45%
of all bearing failures are due
to contaminants in the hydraulic fluid

SAMPLING PROCEDURES

METHODS OF TAKING SAMPLES FROM HYDRAULIC APPLICATIONS USING APPROPRIATE SAMPLE CONTAINERS

Sampling procedures are defined in ISO 4021. Extraction of fluid samples from lines of an operating system. Sample containers should be cleaned in accordance with DIN/1505884. The degree of cleanliness should be verified to ISO 3722.

PREFERRED METHODS

METHOD 1

Using a suitable sampling valve with PTFE sealing method

- Install sampling valve in pressure or return line (in closed condition) at an appropriate point under constant flow or turbulent conditions
- Operate system for at least 30 minutes before taking a sample
- Clean outside of sampling valve
- Open the sampling valve to give appropriate flow rate and flush at least one litre of fluid through the valve **Do Not Close Valve After Flushing**

METHOD 2

Using an unspecified sampling valve

- Install valve in return line or an appropriate point where flow is constant and does not exceed 14 bar / 203 psi
- Operate system for at least 30 minutes before taking a sample
- Flush sampling valve by passing at least 45 litres / 11.89 U.S. Gal through valve back to reservoir
- Disconnect line from valve to reservoir with valve open and fluid flowing

- ● Remove cap from sampling bottle. Ensure cap is retained in hand face downwards
- ● Place bottle under sampling valve. Fill bottle to neck. Cap bottle & wipe.
- ● Close the sampling valve
- ● Label the bottle with the necessary information for analysis e.g. Oil type, running hours, system description etc.

Ensure that all potential risks are assessed and the necessary precautions are taken during the sampling process. Disposal of fluid samples must follow procedures relating to COSHH (Control of Substances Hazardous to Health) and OSHA (Occupational Safety and Health Administration) guidelines.



RESERVOIR SAMPLING

METHOD 3

Use only if methods One & Two cannot be used

- Operate system for at least one hour before taking a sample
- Thoroughly clean area around the point of entry to the reservoir
- Attach sample bottle to the sampling device
- Carefully insert sampling hose into the midway point of the reservoir. Try not to touch sides or baffles within the reservoir
- Extract sample using the vacuum pump and fill to approx 75% volume
- Release vacuum, disconnect bottle and discard fluid
- **Repeat the above four steps three times to ensure flushing of the equipment**
- Attach certified clean sample bottle to sampling device - collect final fluid sample
- Remove bottle from sampling device, cap and wipe - label with appropriate information

BOTTLE DIPPING

METHOD 4

Least preferred method due to possible high ingestion of contamination

- Operate system for at least one hour before taking a sample
- Thoroughly clean area around the point of entry to the reservoir where sample bottle is to be inserted
- Clean outside of certified clean sample bottle using filtered solvent, allow to evaporate and dry
- Dip sample bottle into reservoir, cap and wipe
- Re-seal reservoir access
- Label the bottle with the necessary information for analysis e.g. Oil type, running hours, system description etc.

CONTAMINATION REPORTING FORMATS

NAS 1638

CONTAMINATION CLASSIFICATION STANDARD

The NAS system was originally developed in 1964 to define contamination classes for the contamination contained within aircraft components.

The application of this standard was extended to industrial hydraulic systems simply because nothing else existed at the time.

NAS 1638 has now been made inactive for new design and has been revised to indicate it does not apply to use of Contamination Monitoring Products (CMP).

The coding system defines the maximum numbers permitted of 100 ml volume at various size ranges (differential counts) rather than using cumulative counts as in ISO 4406. Although there is no guidance given in the standard on how to quote the levels, most industrial users quote a single code which is the highest recorded in all sizes and also this convention is used on MP Filtri Contamination Monitors.

The contamination classes are defined by a number (from 00 to 12) which indicates the maximum number of particles per 100 ml, counted on a differential basis, in a given size bracket.

Size Range Classes (in microns)

Maximum Contamination Limits per 100 ml / 3.38 fl. oz.					
Class	5 - 15	15 - 25	25 - 50	50 - 100	>100
00	125	22	4	1	0
0	250	44	8	2	0
1	500	89	16	3	1
2	1 000	178	32	6	1
3	2 000	356	63	11	2
4	4 000	712	126	22	4
5	8 000	1 425	253	45	8
6	16 000	2 850	506	90	16
7	32 000	5 700	1 012	180	32
8	64 000	11 400	2 025	360	64
9	128 000	22 800	4 050	720	128
10	256 000	45 600	8 100	1 440	256
11	512 000	91 200	16 200	2 880	512
12	1 024 000	182 400	32 400	5 760	1 024

5 - 15 µm = 42 000 particles

15 - 25 µm = 2 200 particles

25 - 50 µm = 150 particles

50 - 100 µm = 18 particles

> 100 µm = 3 particles

Class NAS 8

SAE AS4059 - REV. G

CONTAMINATION CLASSIFICATION FOR HYDRAULIC FLUIDS (SAE AEROSPACE STANDARD)

This SAE Aerospace Standard (AS) defines cleanliness levels for particulate contamination of hydraulic fluids and includes methods of reporting data relating to the contamination levels. Tables 1 and 2 below provide differential and cumulative particle counts respectively for counts obtained by a Contamination Monitoring Products (CMP), e.g. LPA3.

Table 1 provides a definition of particulate limits for Classes 00 through 12. A class shall be determined for each particle size range. The reported class of the sample is the highest class in any given particle range size.

NOTE The classes and particle monitors limits in Table 1 are identical to NAS 1638. Measurements of particle are allowed by use of a Contamination Monitoring Products (CMP), or an optical or electron microscope. The size ranges measured and reported should be determined from Table 1 based on the measurement method.

Table 1 - Class for differential measurement

Class	Dimension of contaminant Maximum Contamination Limits per 100 ml / 3.38 fl. oz. (3)				
	5-15 µm	15-25 µm	25-50 µm	50-100 µm	>100 µm (1)
	6-14 µm _(c)	14-21 µm _(c)	21-38 µm _(c)	38-70 µm _(c)	>70 µm _(c) (2)
00	125	22	4	1	0
0	250	44	8	2	0
1	500	89	16	3	1
2	1 000	178	32	6	1
3	2 000	356	63	11	2
4	4 000	712	126	22	4
5	8 000	1 425	253	45	8
6	16 000	2 850	506	90	16
7	32 000	5 700	1 012	180	32
8	64 000	11 400	2 025	360	64
9	128 000	22 800	4 050	720	128
10	256 000	45 600	8 100	1 440	256
11	512 000	91 200	16 200	2 880	512
12	1 024 000	182 400	32 400	5 760	1 024

6 - 14 µm_(c) = 15 000 particles

14 - 21 µm_(c) = 2 200 particles

21 - 38 µm_(c) = 200 particles

38 - 70 µm_(c) = 35 particles

> 70 µm_(c) = 3 particles

SAE AS4059 REV G - Class 6

- (1) Size range, optical microscope, based on longest dimension as measured per AS598 or ISO 4407.
- (2) Size range CMP calibrated per ISO 11171 or an optical or electron microscope with image analysis software, based on projected area equivalent diameter.
- (3) Contamination classes and particle count limits are identical to NAS 1638.

CONTAMINATION REPORTING FORMATS

Table 2 - Class for cumulative measurement

Dimension of contaminant Maximum Contamination Limits per 100 ml / 3.38 fl. oz.						
(1)	>1 µm	>5 µm	>15 µm	>25 µm	>50 µm	>100 µm
(2)	>4 µm _(c)	>6 µm _(c)	>14 µm _(c)	>21 µm _(c)	>38 µm _(c)	>70 µm _(c)
Size code class	A	B	C	D	E	F (3)
000	195	76	14	3	1	0
00	390	152	27	5	1	0
0	780	304	54	10	2	0
1	1 560	609	109	20	4	1
2	3 120	1 217	217	39	7	1
3	6 250	2 432	432	76	13	2
4	12 500	4 864	864	152	26	4
5	25 000	9 731	1 731	306	53	8
6	50 000	19 462	3 462	612	106	16
7	100 000	38 924	6 924	1 224	212	32
8	200 000	77 849	13 849	2 449	424	64
9	400 000	155 698	27 698	4 898	848	128
10	800 000	311 396	55 396	9 796	1 696	256
11	1 600 000	622 792	110 792	19 592	3 392	512
12	3 200 000	1 245 584	221 584	39 184	6 784	1 024

> 4 µm_(c) = 45 000 particles

> 6 µm_(c) = 15 000 particles

> 14 µm_(c) = 1 500 particles

> 21 µm_(c) = 250 particles

> 38 µm_(c) = 15 particles

> 70 µm_(c) = 3 particle

SAE AS4059 REV G
cpc* Class 6/6/5/5/4/2

* cumulative particle count

(1) Size range, optical microscope, based on longest dimension as measured per AS598 or ISO 4407.

(2) Size range CMP calibrated per ISO 11171 or an optical or electron microscope with image analysis software, based on projected area equivalent diameter.

(3) This example is applicable for Rev E only.

The information reproduced on this and the previous page is a brief extract from SAE AS4059 Rev.G, revised in 2022. For further details and explanations refer to the full Standard.

ISO 4405 GRAVIMETRIC LEVEL

The level of contamination is defined by checking the weight of particles collected by a laboratory membrane.

The membrane must be cleaned, dried and desiccated, with fluid and conditions defined by the standard.

The volume of fluid is filtered through the membrane by using a suitable suction system. The weight of the contaminant is determined by checking the weight of the membrane before and after the fluid filtration.



CLEAN
MEMBRANE



CONTAMINATED
MEMBRANE

ISO 4406 CONTAMINATION CODE SYSTEM

The International Standards Organisation standard ISO 4406 is the preferred method of quoting the number of solid contaminant particles in a sample. The level of contamination is defined by counting the number of particles equal or larger than certain dimensions per unit of volume of fluid. The measurement is performed by Contamination Monitoring Products (CMP).

The numbers represent a code which identifies the number of particles of certain sizes in 1ml of fluid. Each code number has a particular size range.

The first scale number represents the number of particles equal to or larger than $4 \mu\text{m}_{(c)}$ per millilitre of fluid;

The second scale number represents the number of particles equal to or larger than $6 \mu\text{m}_{(c)}$ per millilitre of fluid;

The third scale number represents the number of particles equal to or larger than $14 \mu\text{m}_{(c)}$ per millilitre of fluid.

Table 5 ISO 4406 - Allocation of Scale Numbers

Class	Number of particles per ml	
	Over	Up to
28	1 300 000	2 500 000
27	640 000	1 300 000
26	320 000	640 000
25	160 000	320 000
24	80 000	160 000
23	40 000	80 000
22	20 000	40 000
21	10 000	20 000
20	5 000	10 000
19	2 500	5 000
18	1 300	2 500
17	640	1 300
16	320	640
15	160	320
14	80	160
13	40	80
12	20	40
11	10	20
10	5	10
9	2.5	5
8	1.3	2.5
7	0.64	1.3
6	0.32	0.64
5	0.16	0.32
4	0.08	0.16
3	0.04	0.08
2	0.02	0.04
1	0.01	0.02
0	0	0.01

$\geq 4 \mu\text{m}_{(c)}$ = 350 particles

$\geq 6 \mu\text{m}_{(c)}$ = 100 particles

$\geq 14 \mu\text{m}_{(c)}$ = 25 particles

> 16 / 14 / 12

CONTAMINATION REPORTING FORMATS

Microscope counting examines the particles differently to Contamination Monitoring Products (CMP) and the code is given with two scale numbers only. These are at 5 μm and 15 μm equivalent to the 6 $\mu\text{m}_{(c)}$ and 14 $\mu\text{m}_{(c)}$ of Contamination Monitoring Products (CMP).

CONTAMINATION CODE CHART

with 100 ml / 3.38 fl. oz. sample volume

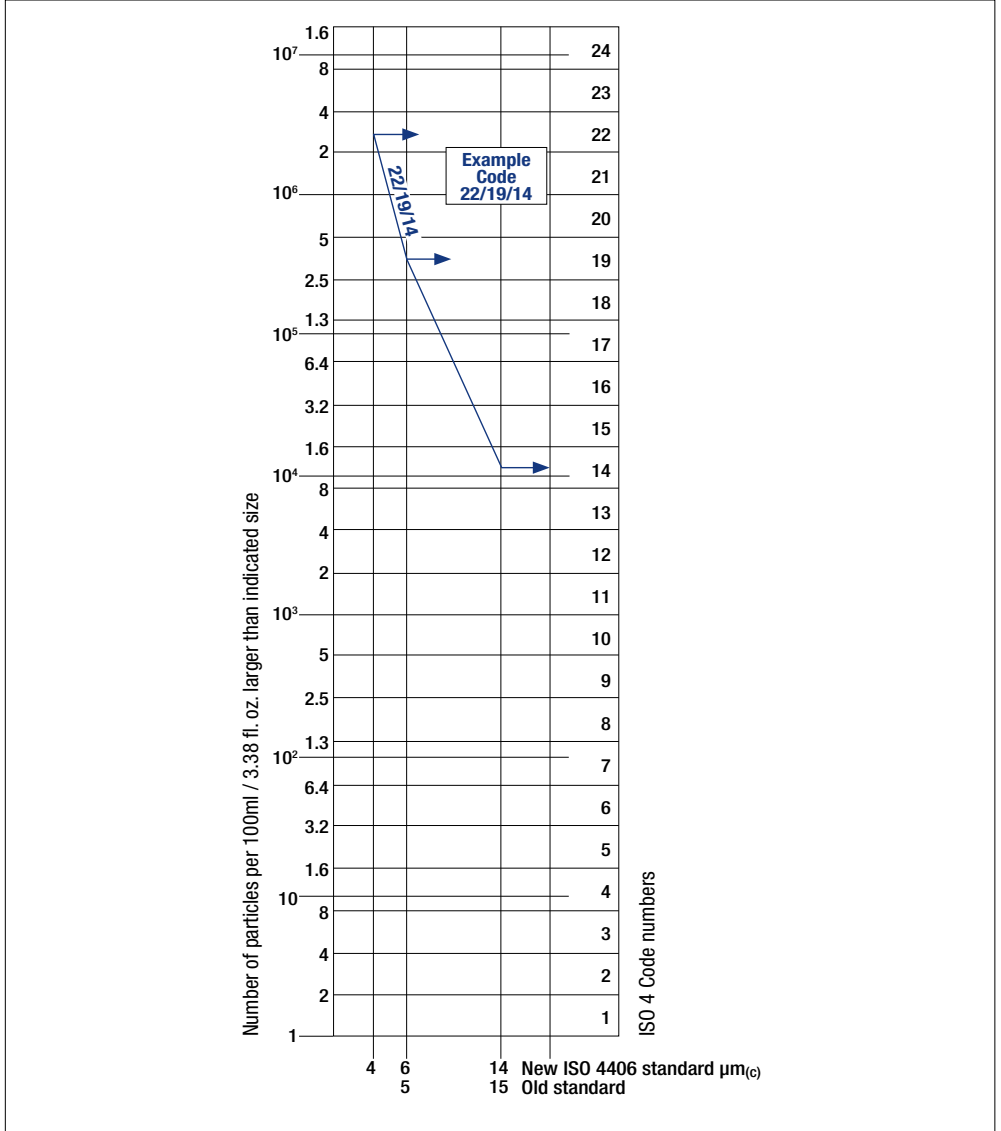

RECOMMENDED CONTAMINATION CLASSES

HYDRAULIC COMPONENT MANUFACTURER RECOMMENDATIONS



Most component manufacturers know the proportionate effect that increased dirt level has on the performance of their components and issue maximum permissible contamination levels. They state that operating components on fluids which are cleaner than those stated will increase life.

However, the diversity of hydraulic systems in terms of pressure, duty cycles, environments, lubrication required, contaminant types, etc, makes it almost impossible to predict the components service life over and above that which can be reasonably expected.

Furthermore, without the benefits of significant research material and the existence of standard contaminant sensitivity tests, **manufacturers who publish recommendations that are cleaner than competitors may be viewed as having a more sensitive product.**

Hence there may be a possible source of conflicting information when comparing contamination levels recommended from different sources.

The table gives a selection of maximum contamination levels that are typically issued by component manufacturer. These relate to the use of the correct viscosity mineral fluid. An even cleaner level may be needed if the operation is severe, such as high frequency fluctuations in loading, high temperature or high failure risk.

Example of recommended contamination levels for pressures below 140 bar - 2031 psi

Piston pumps with fixed flow rate	•					
Piston pumps with variable flow rate			•			
Vane pumps with fixed flow rate		•				
Vane pumps with variable flow			•			
Engines	•					
Hydraulic cylinders	•					
Actuators					•	
Test benches						•
Check valve	•					
Directional valves	•					
Flow regulating valves	•					
Proportional valves				•		
Servo-valves					•	
Flat bearings			•			
Ball bearings				•		
ISO 4406 CODE	20/18/15	19/17/14	18/16/13	17/15/12	16/14/11	15/13/10
Recommended filtration $\beta_{x(c)} \geq 1.000$	$\beta_{21(c)} > 1000$	$\beta_{15(c)} > 1000$	$\beta_{10(c)} > 1000$	$\beta_{7(c)} > 1000$	$\beta_{7(c)} > 1000$	$\beta_{5(c)} > 1000$
MP Filtri media code	A25	A16	A10	A06	A06	A03

CONTAMINANT SIZES

MICRON RATING SIZE COMPARISONS

ISO 4407

CUMULATIVE DISTRIBUTION OF THE PARTICLES SIZE

The level of contamination is defined by counting the number of particles collected by a laboratory filter membrane per unit of fluid volume. The measurement is done by a microscope.

The membrane must be cleaned, dried and desiccated, with fluid and conditions defined by the Standard.

The fluid volume is filtered through the membrane, using a suitable suction system.

The level of contamination is identified by dividing the membrane into a predefined number of areas and by counting the contaminant particles using a suitable laboratory microscope.



MICROSCOPE CONTROL AND MEASUREMENT

Substance	Microns	
	from	to
BEACH SAND	100	2,000
LIMESTONE DUST	10	1,000
CARBON BLACK	5	500
HUMAN HAIR (diameter)	40	150
CARBON DUST	1	100
CEMENT DUST	3	100
TALC DUST	5	60
BACTERIA	3	30
PIGMENTS	0.1	7
TOBACCO SMOKE	0.01	1

1 Micron* = 0.001 mm

25.4 Micron* = 0.001 inch

For all practical purposes particles of 1 micron size and smaller are permanently suspended in air.

100 µm

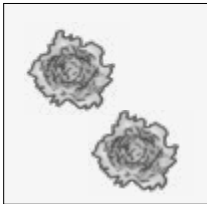

DUST PARTICLE
(dead skin)

75 µm

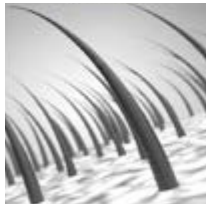

HUMAN HAIR

40 µm

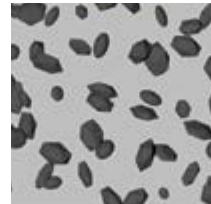

MINIMUM DIMENSION
VISIBLE WITH HUMAN EYES

4 - 14 µm

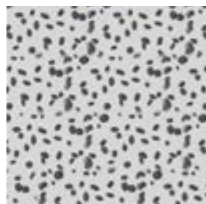

TYPICAL CONTAMINANT DIMENSION IN A HYDRAULIC CIRCUIT

* correct designation = Micrometre

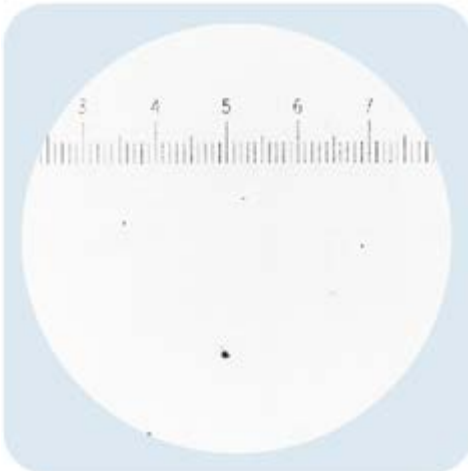

ISO 4406	Class 14/12/9
SAE AS4059 Table 1	Class 3
NAS 1638	Class 3
SAE AS4059 Table 2	Class 4A/3B/3C



ISO 4406	Class 15/13/10
SAE AS4059 Table 1	Class 4
NAS 1638	Class 4
SAE AS4059 Table 2	Class 5A/4B/4C

1 graduation = 10 μm

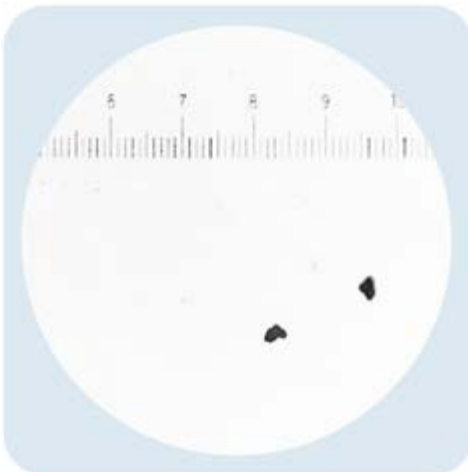

ISO 4406	Class 16/14/11
SAE AS4059 Table 1	Class 5
NAS 1638	Class 5
SAE AS4059 Table 2	Class 6A/5B/5C



ISO 4406	Class 17/15/12
SAE AS4059 Table 1	Class 6
NAS 1638	Class 6
SAE AS4059 Table 2	Class 7A/6B/6C

COMPARISON PHOTOGRAPHS

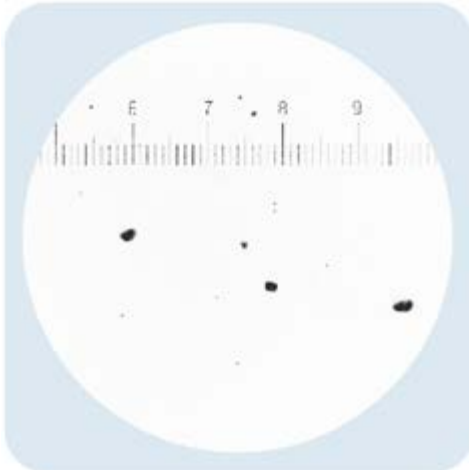

ISO 4406	Class 18/16/13
SAE AS4059 Table 1	Class 7
NAS 1638	Class 7
SAE AS4059 Table 2	Class 8A/7B/7C

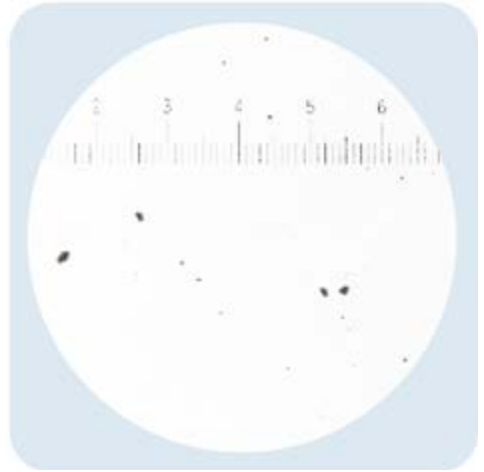

ISO 4406	Class 19/17/14
SAE AS4059 Table 1	Class 8
NAS 1638	Class 8
SAE AS4059 Table 2	Class 9A/8B/8C

1 graduation = 10 μ m



ISO 4406	Class 20/18/15
SAE AS4059 Table 1	Class 9
NAS 1638	Class 9
SAE AS4059 Table 2	Class 10A/9B/9C

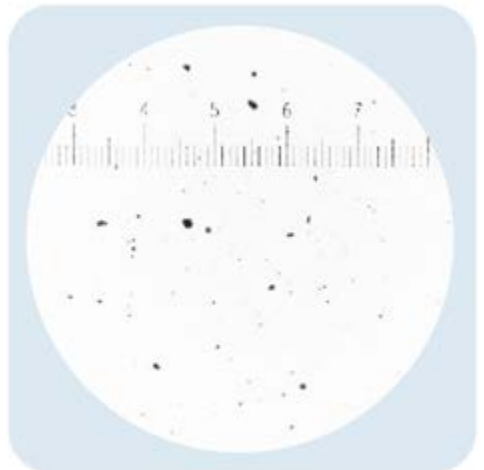

ISO 4406	Class 21/19/16
SAE AS4059 Table 1	Class 10
NAS 1638	Class 10
SAE AS4059 Table 2	Class 11A/10B/10C

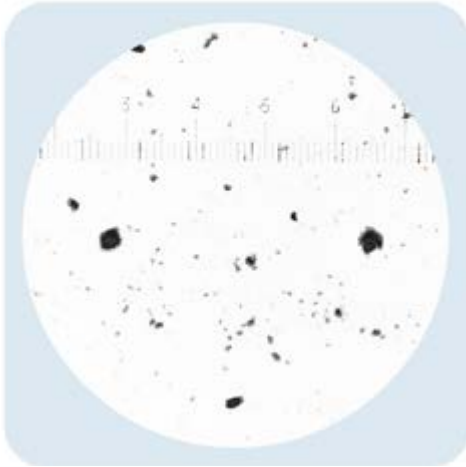

ISO 4406	Class 22/20/17
SAE AS4059 Table 1	Class 11
NAS 1638	Class 11
SAE AS4059 Table 2	Class 12A/11B/11C

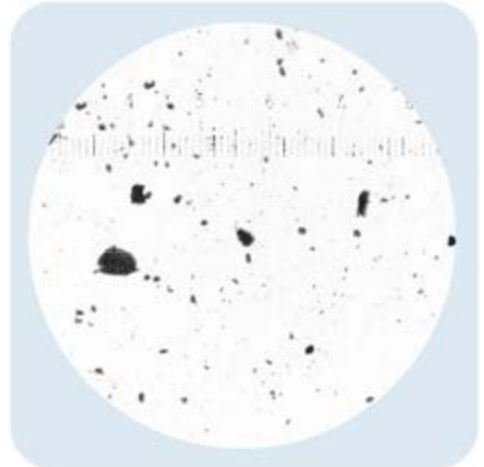

ISO 4406	Class 23/21/18
SAE AS4059 Table 1	Class 12
NAS 1638	Class 12
SAE AS4059 Table 2	Class 13A/12B/12C

1 graduation = 10 µm

CONTAMINATION CLASSES



NAS 12
ISO 23/21/18
Typically new oil as delivered in new certified mild steel 205 ltr barrels



NAS 7
ISO 18/15/13
Typically new oil as delivered in new certified mini containers



NAS 9
ISO 21/18/15
Typically new oil as delivered in oil tankers



NAS 6
ISO 17/15/12
Typically required for most modern hydraulic systems

HYDRAULIC SYSTEM TARGET CLEANLINESS LEVELS

Where a hydraulic system user has been able to check cleanliness levels over a considerable period, the acceptability, or otherwise, of those levels can be verified. Thus if no failures have occurred, the average level measured may well be one which could be made a bench mark.

However, such a level may have to be modified if the conditions change, or if specific contaminant-sensitive components are added to the system. The demand for greater reliability may also necessitate an improved cleanliness level.

The level of acceptability depends on three features:

- the contamination sensitivity of the components
- the operational conditions of the system
- the required reliability and life expectancy

Contamination codes ISO 4406			Correspondent codes NAS 1638	Recommended filtration degree	Typical applications
> 4 $\mu\text{m}_{(c)}$	> 6 $\mu\text{m}_{(c)}$	14 $\mu\text{m}_{(c)}$		$\beta_{x(c)} \geq 1.000$	
14	12	9	3	3	High precision and laboratory servo-systems
17	15	11	6	3 - 6	Robotic and servo-systems
18	16	13	7	10 - 12	Very sensitive High reliability systems
20	18	14	9	12 - 15	Sensitive Reliable systems
21	19	16	10	15 - 25	General equipment of limited reliability
23	21	18	12	25 - 40	Low-pressure equipment not in continuous service

STANDARDS CLEANLINESS CODE COMPARISON

Although ISO 4406 standard is being used extensively within the hydraulics industry other standards are occasionally required and a comparison may be requested. The table below gives a very general comparison but often no direct comparison is possible due to the different classes and sizes involved.

ISO 4406	SAE AS4059 Table 2	SAE AS4059 Table 1	NAS 1638
> 4 $\mu\text{m}_{(c)}$ > 6 $\mu\text{m}_{(c)}$ 14 $\mu\text{m}_{(c)}$	> 4 $\mu\text{m}_{(c)}$ > 6 $\mu\text{m}_{(c)}$ 14 $\mu\text{m}_{(c)}$	4-6 6-14 14-21 21-38 38-70 >70	5-15 15-25 25-50 50-100 >100
23 / 21 / 18	13A / 12B / 12C	12	12
22 / 20 / 17	12A / 11B / 11C	11	11
21 / 19 / 16	11A / 10B / 10C	10	10
20 / 18 / 15	10A / 9B / 9C	9	9
19 / 17 / 14	9A / 8B / 8C	8	8
18 / 16 / 13	8A / 7B / 7C	7	7
17 / 15 / 12	7A / 6B / 6C	6	6
16 / 14 / 11	6A / 5B / 5C	5	5
15 / 13 / 10	5A / 4B / 4C	4	4
14 / 12 / 9	4A / 3B / 3C	3	3

STD grades against temperature

Oil viscosity / temperature chart

Lines shown indicates oils ISO grade Viscosity index of 100.

Lower V.I. oils will have a steeper slope.

Higher V.I. oils will have a flatter slope.

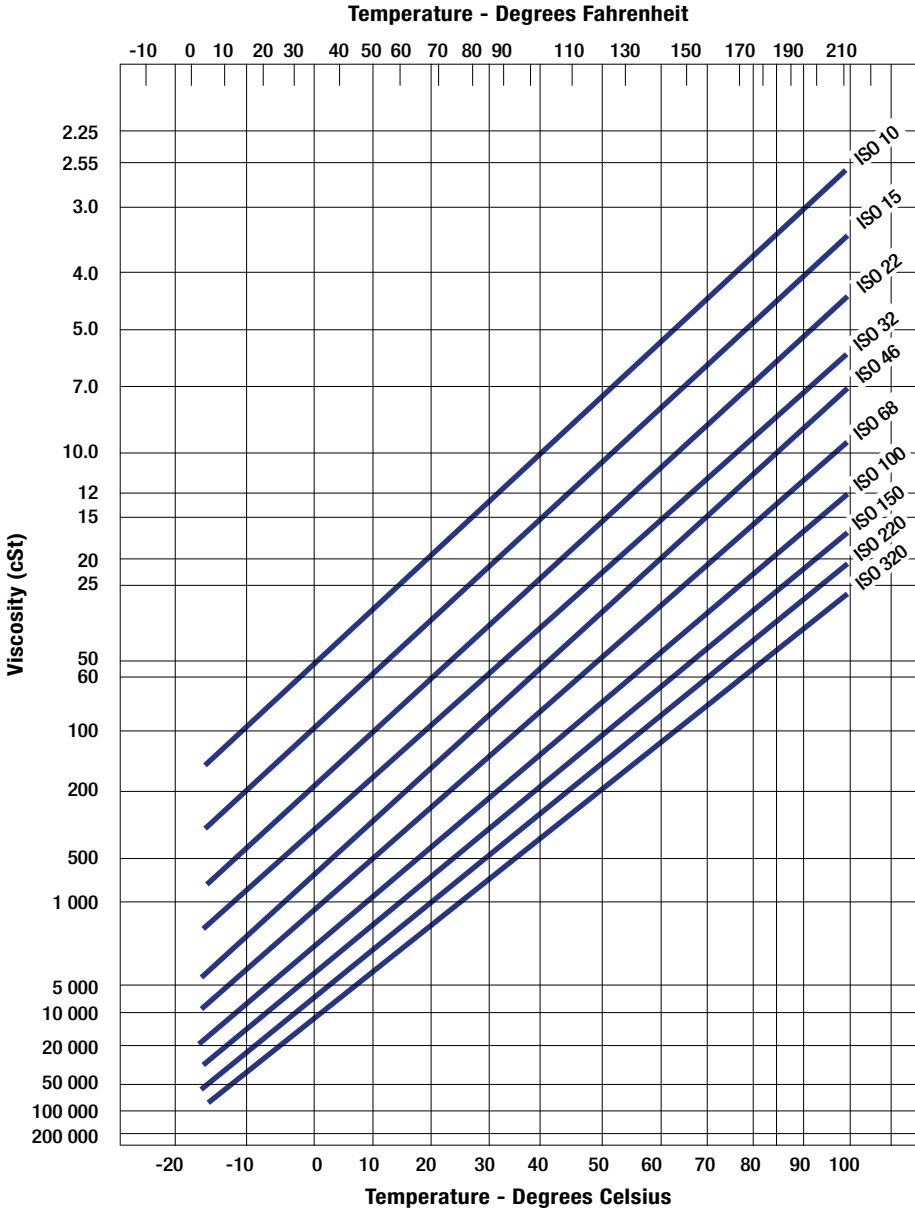

INTRODUCTION TO PARTICLE MONITORING

INTRODUCTION TO PARTICLE MONITORING

Why particle monitoring technology is vital to a clean system

The presence of particles in hydraulic fluid is the prime cause of failure; reliability and performance issues; and shorter component life in hydraulic systems.

This results in reduced lifespans of complex equipment, increased service levels and maintenance costs, and increased amounts of costly unplanned downtime.

Real-time fluid condition monitoring delivers an instant, comprehensive hydraulic health check, which alerts operators to the precise state of contamination in their systems and flags up potential issues and cleanliness trends.

A LITTLE CONTAMINATION GOES A LONG WAY

Only 10 grams of particulate is needed to raise the contamination level of 10,000 Litres (2,641 gallons) of perfectly clean hydraulic fluid to an ISO 4406 value of 19/17/14 (the minimum acceptable level in hydraulic and lube systems).

The life and reliability of hydraulic systems is greatly affected by the presence of particulate contamination in the lubricant. The cleaner the fluid, the more reliable the system or process and the longer the lifespan of the components.

Contamination monitoring of hydraulic fluids is the simplest and most cost-effective monitoring technique and should be a front line technique in any maintenance regime.

THE SCALE OF THE PROBLEM

- Between 70 and 80 per cent of hydraulic failures are caused by contamination build-up
- An estimated 82 per cent of wear and tear is caused by contamination
- A survey by the UK Department of Trade and Industry quantified the relationship between the level of reliability of systems and the quantity of dirt levels in the system as represented by the ISO 4406 Solid Contamination Code

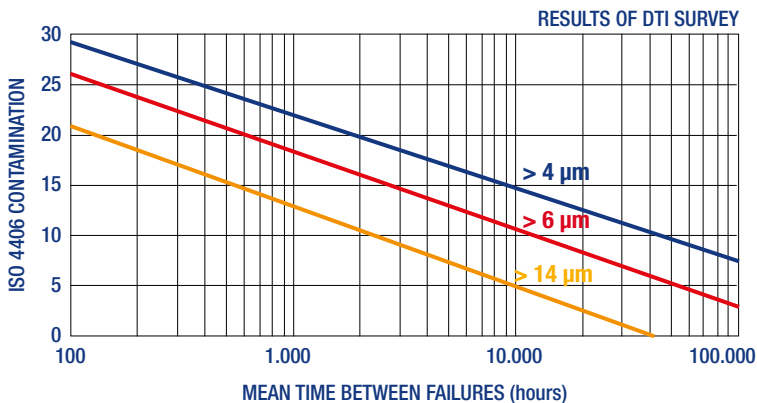



THE IMPORTANCE OF PREVENTIVE CLEANLINESS MAINTENANCE

The aim of more traditional forms of monitoring (vibration, noise, chip detection etc) is the awareness of system degradation so that the component can be taken out of service before catastrophic failure. In most cases the component must be replaced because it is damaged beyond economic repair.

In contamination monitoring, the philosophy is completely different. System fluid samples are analysed for any significant increase in particulate contamination and actions promptly implemented to correct the situation e.g via the use of high-performance hydraulic filtration to improve the system cleanliness to a predefined recommended cleanliness level (RCL) and rapidly reduce system wear and tear in the shortest possible time frame. This way the aims of reliable operation and long component life will be achieved.

KEY REQUIREMENTS FOR A FLUID CONTAMINATION MONITOR

- Needs to be able to measure concentrations of smaller contamination particles i.e. $< 10 \mu\text{m}$
- Needs to measure a wide range of particle sizes and concentrations
- Can present data in standard reporting formats recognized in industry e.g. to cleanliness coding systems such as ISO 4406 or AS4059
- Have proven accuracy and repeatability
- Provides results 'immediately' or at least in a short time period so that corrective actions can be actioned with the minimum delay
- Can analyse a wide range of fluid types e.g. hydraulic, lubrication, wash and solvent fluids
- Have an 'acceptable' cost

HOW CONTAMINATION MONITORING PRODUCTS WORK

PRODUCT CMP

HOW CONTAMINATION MONITORING PRODUCTS WORK

Our contamination monitoring products use a light-extinction principle to identify particles in hydraulic fluids.

The process involves light from a collimated source, passing through optics and then through the oil flow onto a photodiode.

As particles pass through the light source they block the light - creating a 'shadow' (voltage loss) that equates to the size of each particle.

This is measured in signal peaks that can be broken down into 4, 6, 14, 21 $\mu\text{m}_{(c)}$ and greater.

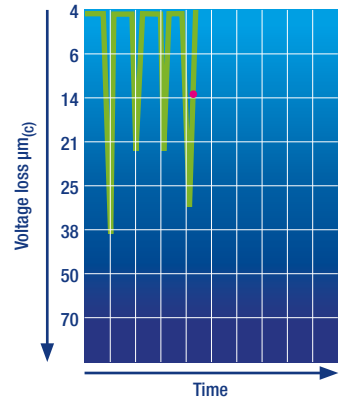
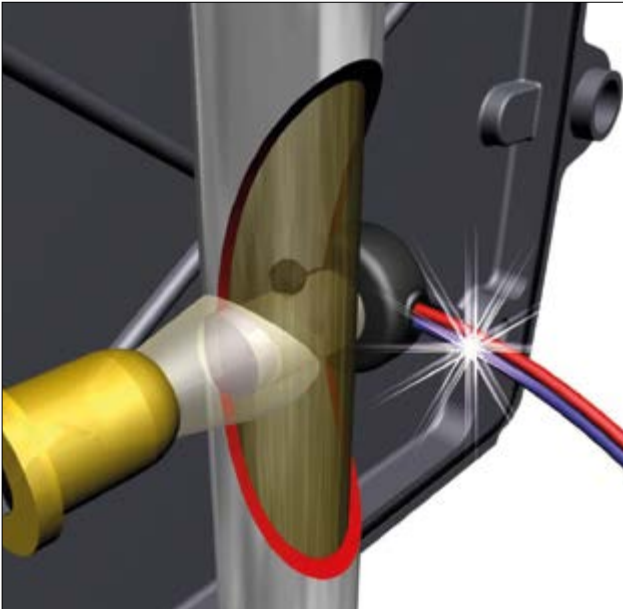

MP Filtri utilises two different methods of light extinction technology for its automatic particle analyser: LED and Twin-Laser particle analysers.



For more details please refer to our dedicate catalogue "CONTAMINATION CONTROL SOLUTIONS"

Scan or click me!

TECHNOLOGY - LED

Fluid Circuit (example: LPA3 product)

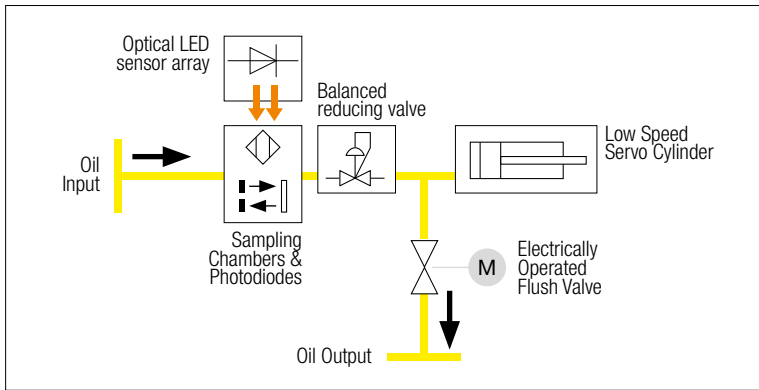

Light source and fluid system

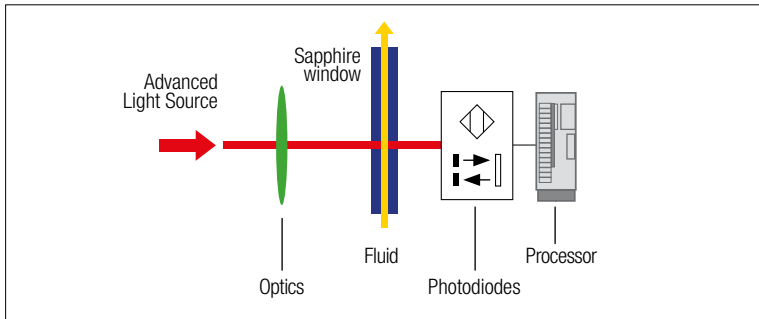

THE FLUSHING PROCESS

MP Filtri's range of portable CMP products have a pre-flush valve built into the product design, which enables the user to flush the unit prior to commencing the analysis procedure, ensuring there is a little external influence on the final analysis reading.

The process allows the user to flush both the sampling point on the system and the microbore hose that connects the system to the CMP. If this procedure is not carried out prior to an analysis these components could have an influence on the final analysis reading. This is due to the fact that the user may not know how much contamination the test point and microbore hose has remaining from previous usage or the effect that would have on the overall particle count and result.

The flushing process is controlled by system pressure. This pressure forces the fluid through the optical sensor. The internally fitted pressure-reducing valve reduces any high pressure from the system to a minimal 1 bar, this ensures the flushing process does not allow system pressure directly through the oil return line of the particle counter back to a waste container. The viscosity and temperature determine the time that is required to flush the particle prior to starting the test. Typically, this can be between one and two minutes.

HOW CONTAMINATION MONITORING PRODUCTS WORKS

THE ANALYSIS PROCESS APPLICABLE TO LPA PRODUCTS

The oil input arrives directly at the optical sensor arrangement, meaning that there is minimal pipework and no dynamic components before the oil is analysed and the particle counter has been flushed.

This reduces the effect that any components or pipework may have on the overall particle count. The oil flow across the sensor is controlled by the low-speed electrohydraulic syringe pump (Servo Cylinder).

The low speed Servo Cylinder has two purposes:

1. To control the speed of the oil that is being analysed. Optical technology requires the particles to travel at a specific velocity for the light source and analysis procedure to count the particles accurately.
2. To measure the quantity of oil the sensor is analysing. This is achieved using a motor tacho unit measuring the quantity of revolutions of the pump cylinder. The media is drawn in through the optical sensing arrangement and balancing valve until the selected volume is achieved. This is selected by the user prior to starting the test.

TECHNOLOGY - TWIN-LASER (ONLY FOR LPA2 AVIATION EDITION)

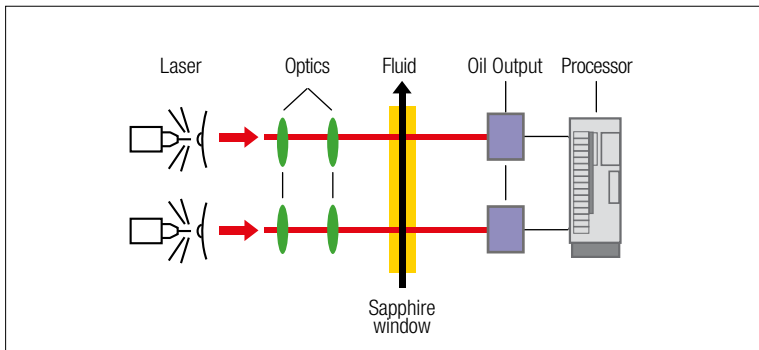
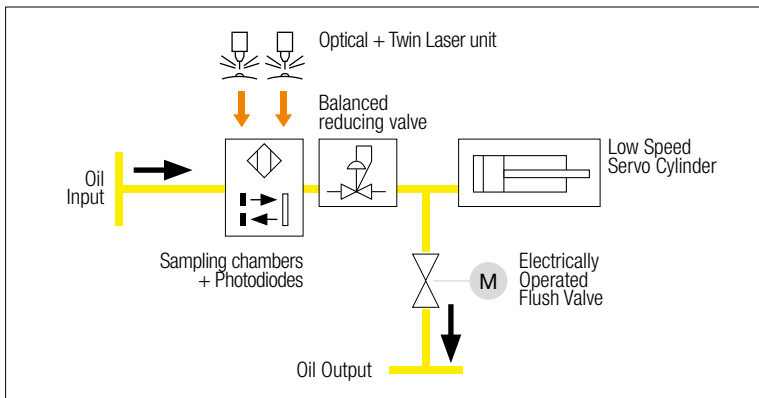

- A single point high accuracy laser designed to measure contamination between $4 \mu\text{m}$ - $6 \mu\text{m}_{(c)}$
- A standard accuracy laser designed to measure system contaminants between $6 \mu\text{m}_{(c)}$ and $70 \mu\text{m}_{(c)}$

Laser Technology

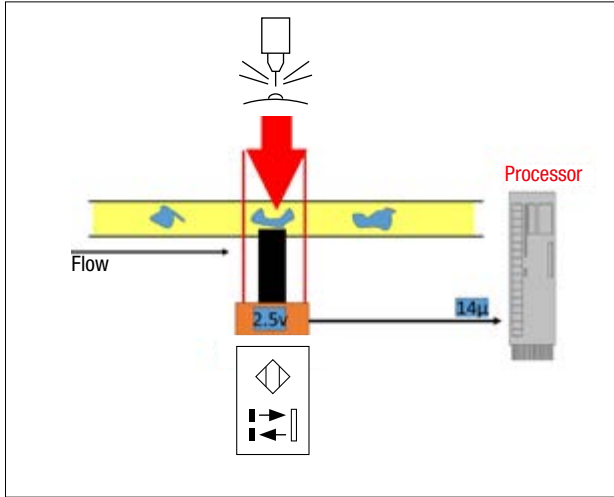

As the particle passes through the laser beam, the loss of light is directly proportional to the size of the particle

LPA

Voltage drop = Size of particle

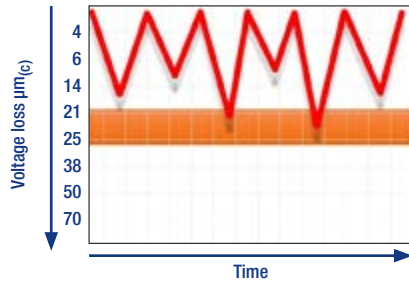
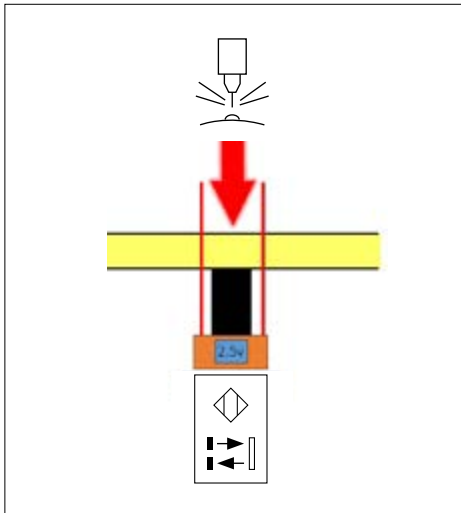

CALIBRATION PROCEDURES AND TEST DUST

Original particle monitoring methods were initially performed using optical microscopes (ARP 598) utilizing the NAS1638 reporting format.

The original method was the ISO 4402 calibration procedure, based on optical microscopy, referred to the largest particle size, measured as μm (micron) size and utilizing ACFTD (Air Cleaner Fine Test Dust) as the media.

When Automatic Particle Monitors first came to market, these provided a faster method of analyzing samples but required a different method of calibration. Then, an improved procedure and related test dust have been created, based on particle sizes determined using Automatic Particle Monitor, referring to the diameter of a circle with the same surface area as the particle (sample standard per ISO NIST), measured as $\mu\text{m}_{(c)}$ (micron c) size.

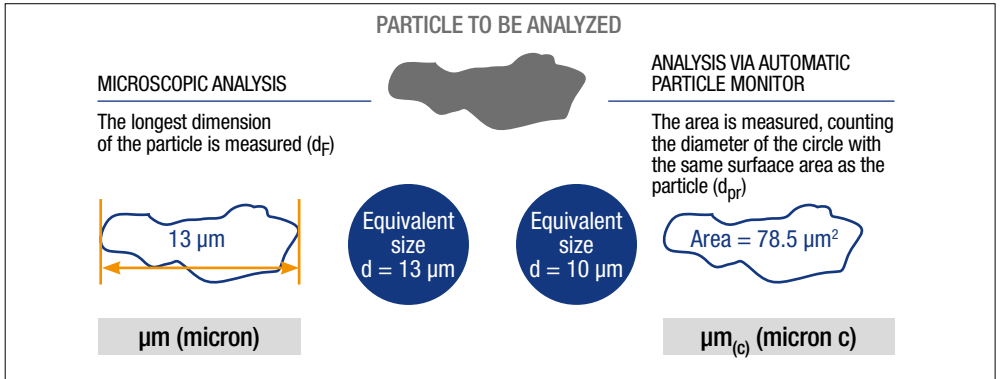

Figure 1

Used contaminant dust is known as ISO Test Dust (as per ISO 12103-1), calibrated with more sophisticated instruments. ISO Medium Test Dust (ISO MTD: ISO 12103-A3) is the applicable test dust utilized for calibration of light extinction-based CMP.

There is a slight difference between particle measurements from the two methods. To retain the same cleanliness standard, calibrations using ISO MTD vs. ACFTD are corrected to the following particle scale:

Comparison													
ACFTD	<1 μm	2 μm	3 μm	5 μm	7 μm	10 μm	15 μm	20 μm	25 μm	30 μm	50 μm	75 μm	100 μm
ISO MTD	4 $\mu\text{m}_{(c)}$	4.6 $\mu\text{m}_{(c)}$	5.1 $\mu\text{m}_{(c)}$	6.4 $\mu\text{m}_{(c)}$	7.7 $\mu\text{m}_{(c)}$	9.8 $\mu\text{m}_{(c)}$	13.6 $\mu\text{m}_{(c)}$	17.5 $\mu\text{m}_{(c)}$	21 $\mu\text{m}_{(c)}$	25 $\mu\text{m}_{(c)}$	38 $\mu\text{m}_{(c)}$	50* $\mu\text{m}_{(c)}$	70* $\mu\text{m}_{(c)}$

* estimated

ISO MTD also forms the basis for the NIST certified standard reference materials (SRM) - SRM2806 and Reference Material (RM) - RM8631.

Standard Reference material (SRM) 2806 is composed of mineral dust ISO MTD suspended in MIL-PRF-5606 / NATO H-515 hydraulic oil. SRM 2806 is a traceable particle count standard and is certified for number of particles larger than a specified size per milliliter of hydraulic oil.

A unit of ISO MTD Reference Material (RM) 8631 consists of 20 g of a mineral dust that is heterogeneous in composition and polydisperse with respect to size. RM 8631 is intended to be used as a secondary material for calibrating particle sizing instruments.

Calibration procedures for light extinction-based CMP using ISO MTD as test dust are the standards ISO 11171 (*Hydraulic fluid power - Calibration of Automatic Particle Counters for Liquids*) and ISO 11943 (*Hydraulic fluid power - online automatic particle-counting systems for liquids - Methods of calibration and validation*).

TYPICAL DIAGRAM OF A HYDRAULIC CIRCUIT

Increasing pressure in a hydraulic system means increasing viscosity of oil.

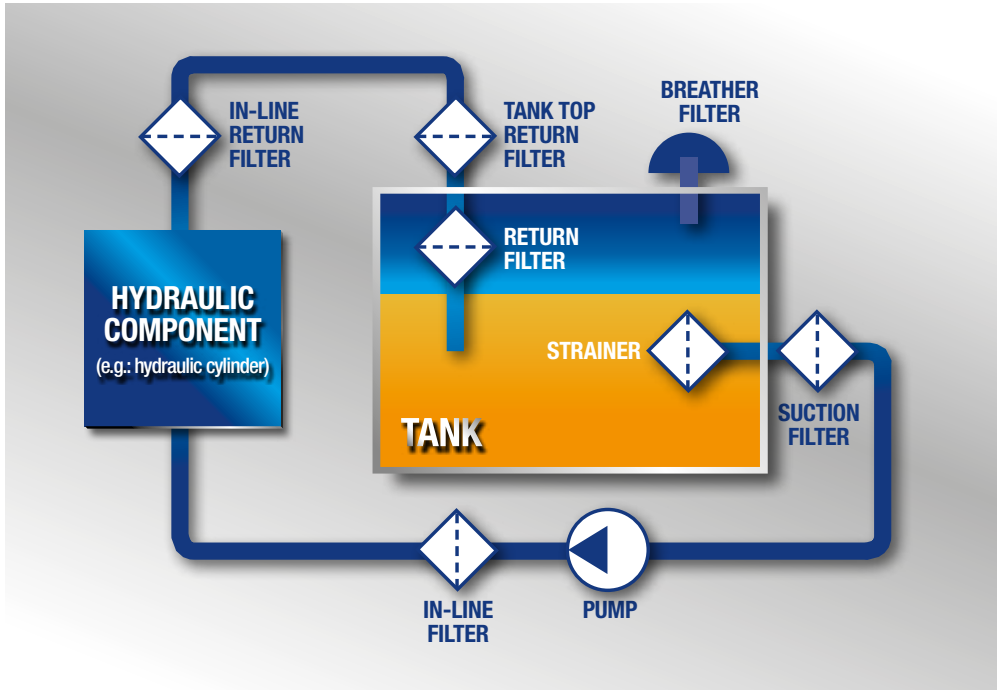

Variation of viscosity due to the increasing pressure

ISO VG (cSt)	Pressure [bar / psi]					
	bar	50	100	200	300	400
	psi	725	1450	2900	4350	5800
Viscosity Increase (cSt)						
32	35	38	46	54	66	
46	50	55	66	77	94	
68	75	81	98	114	140	
100	109	119	143	167	205	
220	240	261	315	367	450	
320	349	380	458	534	655	

For more details please refer to our specialist catalogue "HYDRAULIC FILTRATION"



Scan or click me!

FILTER SIZING CALCULATION

THE CORRECT FILTER SIZING HAS TO BE BASED ON THE TOTAL PRESSURE DROP DEPENDING ON THE APPLICATION.

The pressure drop calculation is performed by adding together the value of the housing with the value of the filter element. The pressure drop Δp_c of the housing is proportional to the fluid density (kg/dm^3 / lb/ft^3). The filter element pressure drop Δp_e is proportional to its viscosity (mm^2/s / SUS), the corrective factor Y have to be used in case of an oil viscosity different than $30 \text{ mm}^2/\text{s}$ (cSt) / 150 SUS .

Sizing data for single filter element, head at top

Δp_c = Filter housing pressure drop [bar / psi]

Δp_e = Filter element pressure drop [bar / psi]

Y = Corrective factor Y (see correspondent table), depending on the filter type, on the filter element size, on the filter element length and on the filter media

Q = flow rate (l/min - gpm)

$V1$ reference oil viscosity = $30 \text{ mm}^2/\text{s}$ (cSt) / 150 SUS

$V2$ = operating oil viscosity in mm^2/s (cSt) / SUS

Filter element pressure drop calculation with an oil viscosity different than $30 \text{ mm}^2/\text{s}$ (cSt) / 150 SUS

International system:

$$\Delta p_e = Y : 1000 \times Q \times (V2:V1)$$

Imperial system:

$$\Delta p_e = Y : 17.2 \times Q \times (V2:V1)$$

$$\Delta p_{\text{Tot.}} = \Delta p_c + \Delta p_e$$

Verification formula

$$\Delta p_{\text{Tot.}} \leq \Delta p_{\text{max allowed}}$$

Maximum total pressure drop (Δp_{max}) allowed by a new and clean filter

Filter family	Δp_{max}	
	[bar]	[psi]
Return filters	0.50 bar	7.25 psi

Filter pressure drop calculation example

Application data:

Selected filter: **MPTX110 length 40**

Selected filter element: **MF100 length 40**

Selected connection: G 1 1/4"

Selected filtration rating: **25 μm** absolute filtration with microfibre

Pressure $P_{\text{max}} = 10 \text{ bar}$ / 145.03 psi

Flow rate $Q = 120 \text{ l/min}$ / 31.7 gpm

Viscosity $V2 = 46 \text{ mm}^2/\text{s}$ (cSt) / 216 SUS

Oil density = $0.86 \text{ kg}/\text{dm}^3$ / $53.68 \text{ lb}/\text{ft}^3$

Calculation:

$\Delta p_c = 0.03 \text{ bar} / 0.43 \text{ psi}$ (see graphic below)

MPTX 110 - Length 30 - 40

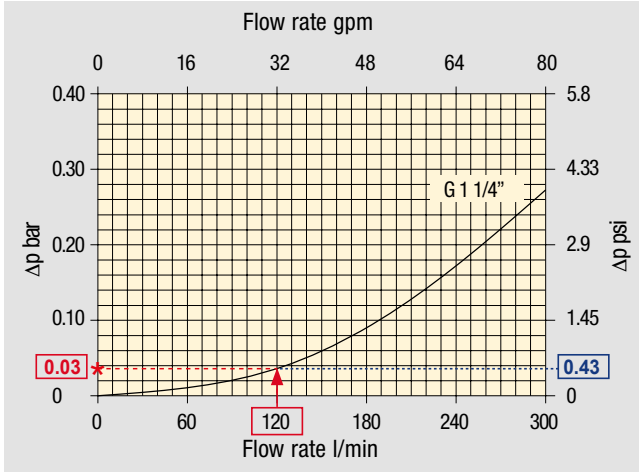

Filter housings Δp pressure drop. The curves are plotted using mineral oil with density of 0.86 kg/dm^3 in compliance with ISO 3968. Δp varies proportionally with density.

Filter element		Absolute filtration Filter Elem. Δp Series: H					Nominal filtration Filter Elem. Δp Series: N			
Type	Length	A0003	A0006	A0010	A0016	A0025	P0010	P0025	M0025 M0060 M0090	
MFX 030	10	74.00	50.08	20.00	16.00	9.00	6.43	5.51	3.40	
	10	28.20	24.40	8.67	8.17	6.88	4.62	3.96	1.25	
MFX 100	20	17.33	12.50	6.86	5.70	4.00	3.05	2.47	1.10	
	30	10.25	9.00	3.65	3.33	2.50	1.63	1.32	0.96	
	40	6.10	5.40	2.30	2.20	2.00	1.19	0.96	0.82	

$$\Delta p_e = (2.00 : 1000) \times 120 \times (46 : 30) = 0.37 \text{ bar}$$

$$\Delta p_e = (2.00 : 17.2) \times 32 \times (216 : 150) = 5.36 \text{ psi}$$

$$\sqrt{\Delta p_{\text{Tot.}} = 0.03 + 0.37 = 0.4 \text{ bar}}$$

$$\sqrt{\Delta p_{\text{Tot.}} = 0.43 + 5.36 = 5.79 \text{ psi}}$$

The selection is correct because the total pressure drop value is inside the admissible range for top tank return filters. In case the max allowed total pressure drop is not verified, it is necessary to repeat the calculation changing the filter and/or filter element length/size.

For more details please refer to our dedicated page "FILTER SIZING SOFTWARE"



Scan or click me!

FILTER ELEMENT BETA RATIO INFORMATION

FILTER BETA RATIOS

The Beta Ratio equals the ratio of the number of particles of a maximum given size upstream of the filter to the number of particles of the same size and larger found downstream. Simply put, the higher the Beta Ratio the higher the capture efficiency of the filter.

Beta Ratio

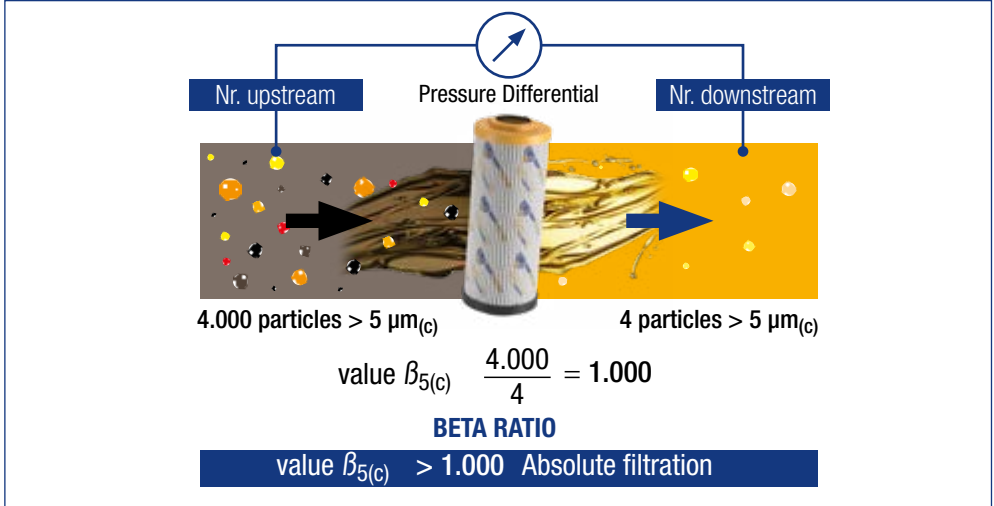

Filtration efficiency - Beta Ratio

Beta	2	10	50	75	100	200	1000	2000
%	50	90	98	98.7	99	99.5	99.9	99.95

Filtration ISO standard comparison

MP FILTRI FILTRATION GRADE	ISO 4572	ISO 16889
	$\beta_x > 200$	$\beta_{x(c)} > 1000$
A (00) 03	3 μm	5 $\mu\text{m}_{(c)}$
A (00) 06	6 μm	7 $\mu\text{m}_{(c)}$
A (00) 10	10 μm	10 $\mu\text{m}_{(c)}$
A (00) 16	18 μm	15 $\mu\text{m}_{(c)}$
A (00) 25	25 μm	21 $\mu\text{m}_{(c)}$

Filtration grade - Beta Ratio

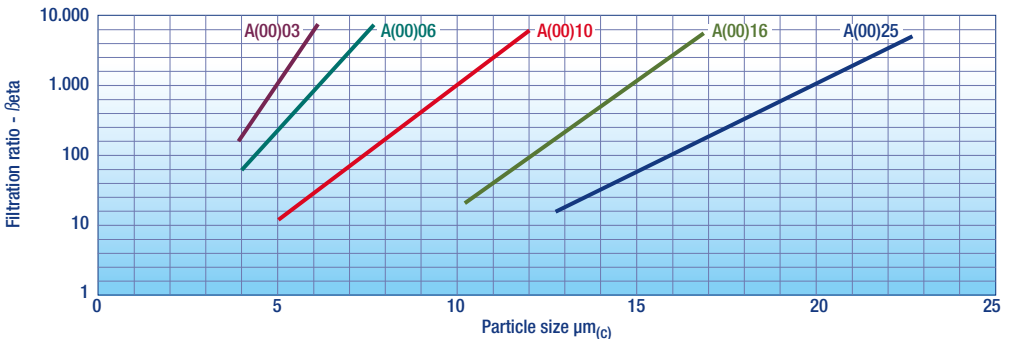

TECHNICAL INFORMATION

The flow of fluids (either laminar or turbulent) is determined by evaluating the Reynolds number of the flow. The Reynolds number, based on studies of Osborn Reynolds (**), is a dimensionless number comprised of the physical characteristics of the flow.

For practical purposes, if the Reynolds number is less than 2000, the flow is laminar. If it is greater than 3500, the flow is turbulent. Flows with Reynolds numbers between 2000 and 3500 are sometimes referred to as transitional flows.

In practice for hydraulic/lubrication systems turbulent flow is achieved when the Reynolds number is greater than 4000 (Re > 4000).

Reynolds number is given by (Re) = $21220 \times \frac{Q}{di \times v}$

Where:

Q = Volumetric Flow Rate (litres/min - gpm)

di = Inside diameter or equivalent diameter of largest flow gallery (mm/in)

v = Viscosity of the flushing fluid at normal flushing temperature (Cst)

*(**) Reynolds most famously studied the conditions in which the flow of fluid in pipes transitioned from laminar flow to turbulent flow. In 1883 Reynolds demonstrated the transition to turbulent flow in a classic experiment in which he examined the behaviour of water flow under different flow rates using a small jet of dyed water introduced into the centre of flow in a larger pipe. From these experiments came the dimensionless Reynolds number for dynamic similarity, the ratio of inertial forces to viscous forces.*

FLUSHING INFORMATION FOR VARIOUS PIPE DIAMETERS

Component cleaning/flushing systems can only be effective if turbulent flow is achieved.

The following guideline is with a fluid having a 86 kg/m³ / 0.718 lb/gal fluid density (typical mineral oils) and 30 cSt viscosity.

Nominal pipe size	Core		Flow for Re = 4000	
	[in]	[mm]	[l/min]	[gpm]
1/4"	0.451	11.5	65	17.17
1/2"	0.734	18.6	105	27.74
1"	1.193	30.3	171	45.17
1 1/4"	1.534	39.0	220	58.12
1 1/2"	1.766	44.9	254	67.10
2"	2.231	56.7	320	84.54

WATER IN HYDRAULIC AND LUBRICATING FLUIDS

WATER CONTENT

In mineral oils and non aqueous resistant fluids water is undesirable. Mineral oil usually has a water content of 50-500 ppm (@40°C / 104°F) which it can support without adverse consequences. Once the water content exceeds about 500 ppm the oil starts to appear hazy. Above this level there is a danger of free water accumulating in the system in areas of low flow. This can lead to corrosion and accelerated wear.

Similarly, fire resistant fluids have a natural water which may be different to mineral oil.

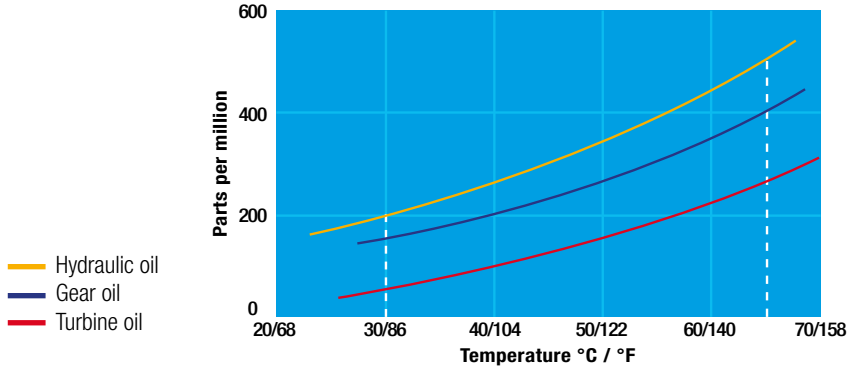

SATURATION LEVELS

Since the effects of free (also emulsified) water is more harmful than those of dissolved water, water levels should remain well below the saturation point.

However, even water in solution can cause damage and therefore every reasonable effort should be made to keep saturation levels as low as possible. There is no such thing as too little water. As a guideline, we recommend maintaining saturation levels below 50% in all equipment.

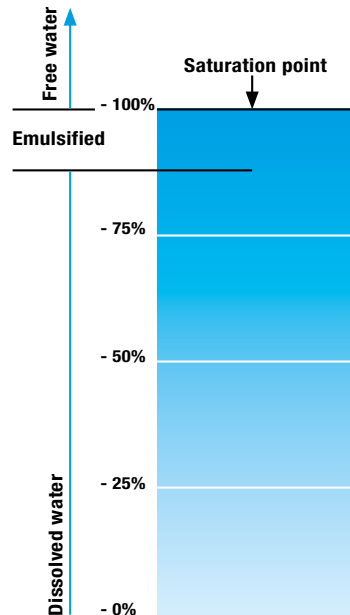

TYPICAL WATER SATURATION LEVEL FOR NEW OILS

Examples:

Hydraulic oil @ 30°C / 86°F = 200 ppm = 100% saturation

Hydraulic oil @ 65°C / 149 °F = 500 ppm = 100% saturation

WATER ABSORBER

Water is present everywhere, during storage, handling and servicing.

MP Filtri filter elements feature an absorbent media which protects hydraulic systems from both particulate and water contamination.

MP Filtri filter element technology is available with inorganic microfiber media with a filtration rating 25 μm (therefore identified with media designation WA025, providing absolute filtration of solid particles to $\beta_{x(c)} = 1000$).

Absorbent media is made by water absorbent fibres which increase in size during the absorption process.

Free water is thus bonded to the filter media and completely removed from the system (it cannot even be squeezed out).

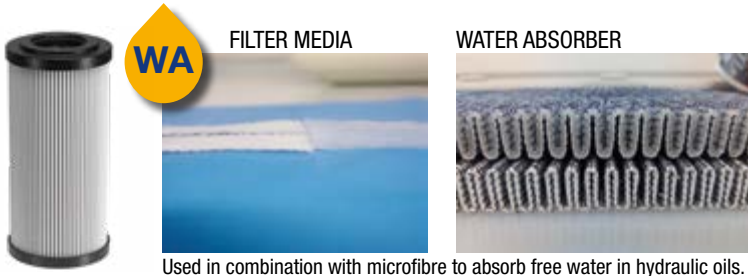

Used in combination with microfibre to absorb free water in hydraulic oils.

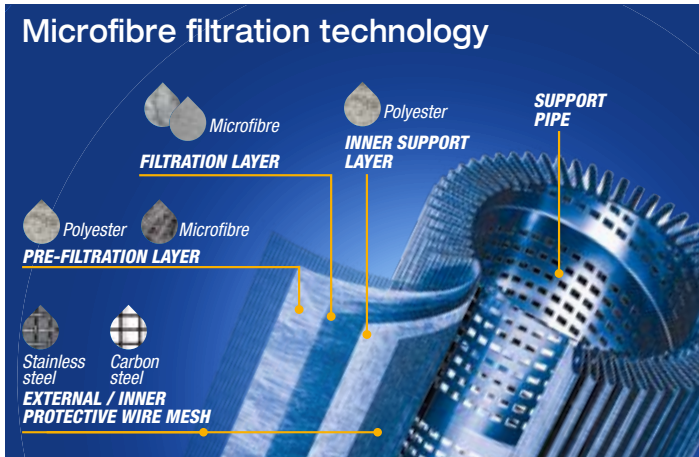

For more details please refer to our dedicate brochure "WATER REMOVAL"



Scan or click me!

By removing water from your fluid power system, you can prevent such key problems as:

- corrosion (metal etching)
- loss of lubricant power
- accelerated abrasive wear in hydraulic components
- valve-locking
- bearing fatigue
- viscosity variance (reduction in lubricating properties)
- additive precipitation and oil oxidation
- increase in acidity level
- increased electrical conductivity (loss of dielectric strength)
- slow/weak response of control systems

FLUID COMPATIBILITY TABLES

FLUID COMPATIBILITY TABLES

CONTAMINATION MONITORING PRODUCTS

For more details please refer to “FLUID COMPATIBILITY CHARTS”



Scan or click me!

HYDRAULIC FILTRATION PRODUCTS

For more details please refer to “FLUID COMPATIBILITY CHARTS”



Scan or click me!

All data, details and words contained in this publication are provided for use by technically qualified personnel at their discretion, without warranty of any kind.

MP Filtri reserves the right to make modifications to the models and versions of the described products at any time for both technical and/or commercial reasons.

For updated information please visit our website: www.mpfiltri.com

The colors and the pictures of the products are purely indicative.

Any reproduction, partial or total, of this document is strictly forbidden.

All rights are strictly reserved

WORLDWIDE NETWORK

CANADA ♦ CHINA ♦ FRANCE ♦ GERMANY ♦ INDIA ♦ SINGAPORE
UNITED ARAB EMIRATES ♦ UNITED KINGDOM ♦ USA



HQ
ITALY

A world map in shades of blue with several yellow location markers. A callout bubble points to the HQ in Italy. The map is framed by golden curved lines on the sides.



PASSION  PERFORM

in @ y f



mpfiltri.com

Scan or click me!

MF010000074
EN - 2026.03