

# FZB series

Maximum working pressure up to 32 Mpa (320 bar) - Flow rate up to 70 l/min



# TYPICAL FILTER SIZING Selection Software

## Step ①

Select "FILTER SIZING SOFTWARE" after login

OR

Select "FILTER SIZING" after login from a product page

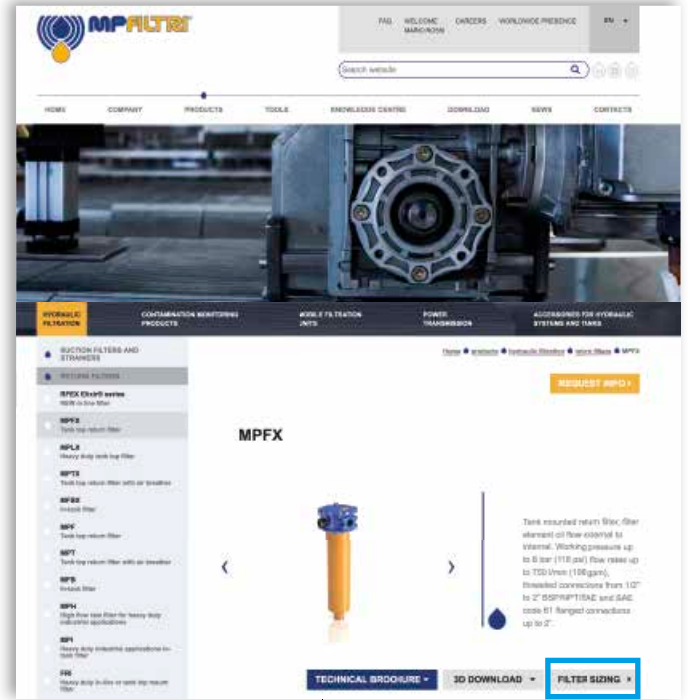

Choose the type of filter family.  
Enter the main data for sizing the filter  
then push CALCULATE.

## Step ②

Enter the main data for sizing the filter  
then push CALCULATE.

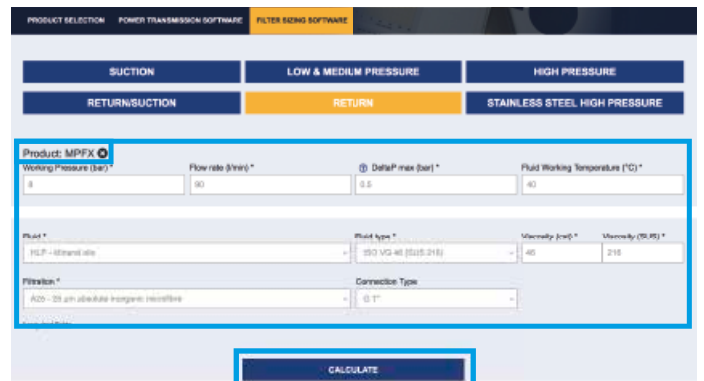
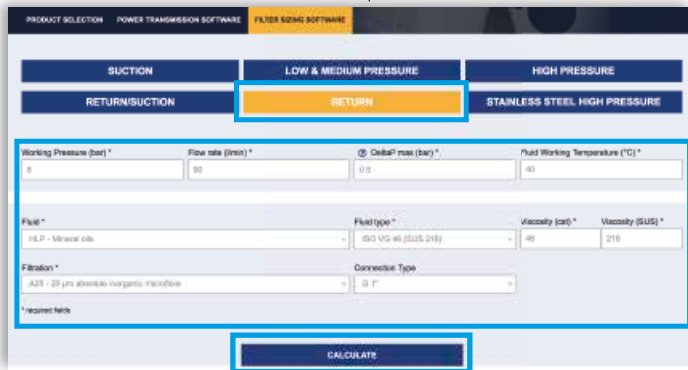

## Step ③

Select the desired options to choose the appropriate filter type for the application.

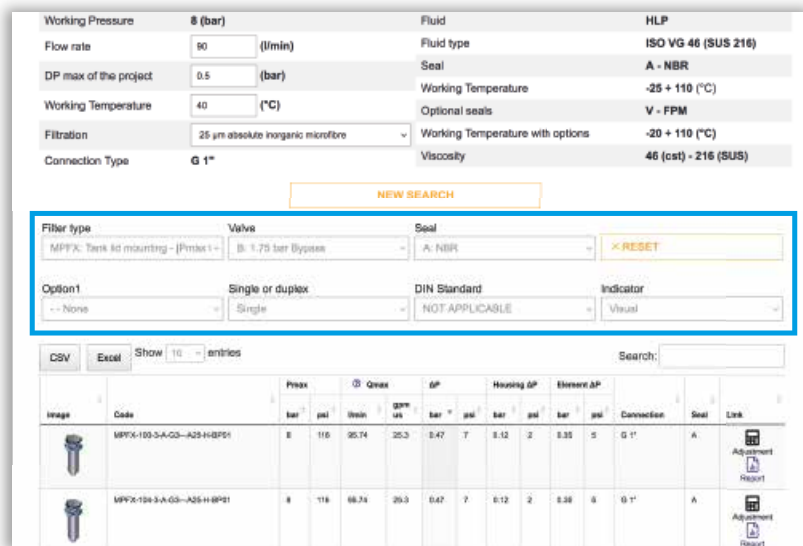

## Step 4

Choose the most suitable filter from the proposed list.

Image	Code	Peak bar	Qmax gal/min	ΔP bar	Housing ΔP bar	Element ΔP bar	Connection	Seal	Link			
	MPFX-103-3-A-Q3-A25-H-BPFI	8	116	25.74	25.3	0.47	T	0.12 2	0.33 5	G 1"	A	Adjustment Report
	MPFX-104-3-A-Q3-A25-H-BPFI	8	116	25.74	25.3	0.47	T	0.12 2	0.33 5	G 1"	A	Adjustment Report

## Step 5

It is possible to change the filter modifying every parameter.

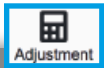

### A SAVE YOUR FILTER'S REPORT



### B MANUAL EDIT



SAVE IN YOUR ARCHIVE  
typing your reference data and then SAVE AS PDF



A new browser window displays the pdf

see A

Close the report window



By clicking your WELCOME button, the SHOW REPORTS is displayed: select it to see your filters list.

## Description

## Technical data

### Stainless steel high pressure filters

#### Manifold

**Maximum working pressure up to 32 Mpa (320 bar)**  
**Flow rate up to 70 l/min**

FZB is a range of stainless steel high pressure filter for protection of sensitive components in high pressure hydraulic systems placed in difficult environmental conditions.

They are directly connected to the side of the manifold, through the proper flanged interface.

#### Available features:

- Manifold connections up to Ø16 mm, for a maximum flow rate of 70 l/min
- Fine filtration rating, to get a good cleanliness level into the system
- Bypass valve, to relieve excessive pressure drop across the filter media
- Low collapse filter element with external support "R", for filter element protection against the back pressure caused by the check valve or the reverse flow in filters provided with the bypass valve
- High collapse filter element with external support "S", for filter element protection against the back pressure caused by the check valve or the reverse flow in filters not provided with the bypass valve
- High collapse filter element "U", for use with aggressive fluids
- Visual, electrical and electronic differential clogging indicators

#### Common applications:

- Off-shore equipment
- Water filtration systems
- Systems with strong or corrosive environmental conditions
- Systems with corrosive fluids

#### Filter housing materials

- Head: AISI 316L
- Housing: AISI 316L
- Bypass valve: AISI 316L

#### Seals

- Standard NBR series A (-25 °C to +110 °C)
- Optional FPM series V (-20 °C to +120 °C)
- Optional MFQ series F (-50 °C to +120 °C)

#### Bypass valve

Opening pressure 6 bar ±10%

#### Temperature

From -50 °C to +120 °C

#### Note

FZB filters are provided for vertical mounting

#### Δp element type

Fluid flow through the filter element from OUT to IN

Microfibre filter elements - series R: 20 bar.

Element series "R":

- End cap: Polyamide
- Core tube: Tinned steel
- External/Internal support: Wire mesh Epox painted
- Media/Support/Pre-filter: Microfibre/Syntetic

Microfibre filter elements - series S: 210 bar.

Element series "S":

- End cap: Tinned steel
- Core tube: Tinned steel
- External support: Wire mesh Epox painted
- Internal support: Wire mesh Stainless steel
- Media/Support/Pre-filter: Microfibre/Syntetic

Stainless Steel Microfibre filter elements series U: 210 bar.

Element series "U":

- End cap: Stainless steel
- Core tube: Stainless steel
- External support: Stainless steel
- Internal support: Stainless steel
- Media/Support/Pre-filter: Microfibre/Syntetic

## Weights [kg] and volumes [dm<sup>3</sup>]

Filter series	Weights [kg]				Volumes [dm <sup>3</sup> ]					
	Length	1	2	3	4	Length	1	2	3	4
<b>FZB 039</b>	-	4.6	5.2	5.7	-	0.19	0.26	0.34		

Filter series	Length	Filter element design - R Series					Filter element design - S Series					Filter element design - U Series				
		A03	A06	A10	A16	A25	A03	A06	A10	A16	A25	A03	A06	A10	A16	A25
<b>FZB 039</b>	<b>2</b>	18	23	39	44	52	18	22	37	40	48	18	22	37	40	48
	<b>3</b>	31	33	47	54	65	28	31	43	46	84	28	31	43	46	84
	<b>4</b>	38	41	56	63	71	34	36	48	62	68	34	36	48	62	68

### Maximum flow rate for a complete stainless steel high pressure filter with a pressure drop $\Delta p = 1.5$ bar.

The reference fluid has a kinematic viscosity of 30 mm<sup>2</sup>/s (cSt) and a density of 0.86 kg/dm<sup>3</sup>.

For different pressure drop or fluid viscosity we recommend to use our selection software available on [www.mpfiltri.com](http://www.mpfiltri.com).

You can also calculate the right size using the formulas present on the FILTER SIZING paragraph at the beginning of the full catalogue or at the beginning of the filter family brochure.

Please, contact our Sales Department for further additional information.

### Hydraulic symbols

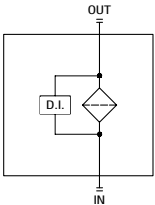
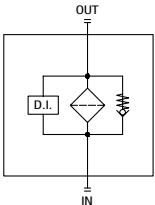
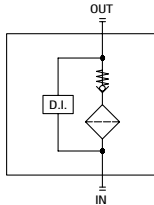
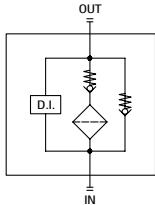
Filter series	Style S	Style B	Style T	Style D
<b>FZB 039</b>	•	•	•	•
				

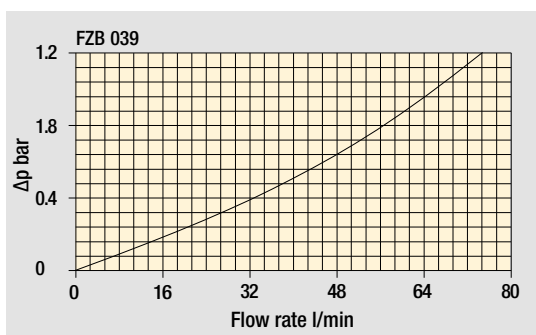

The curves are plotted using mineral oil with density of 0.86 kg/dm<sup>3</sup> in compliance with ISO 3968.  $\Delta p$  varies proportionally with density.

Pressure drop  
Filter housings  $\Delta p$  pressure drop

## Designation & Ordering code

### COMPLETE FILTER

Series and size **FZB039** Configuration example: **FZB039** **2** **T** **A** **F** **2** **A06** **S** **P01**

Length **2** | **3** | **4** |

Valves  
**S** Without bypass  
**B** With bypass 6 bar  
**T** With check valve, without bypass  
**D** With check valve, with bypass 6 bar

Seals  
**A** NBR  
**V** FPM  
**F** MFQ

Connections  
**F** Manifold

Connections for differential indicator  
**1** Without connection  
**2** With connection on the top

Filtration rating (filter media)  
**A03** Inorganic microfiber 3 µm  
**A06** Inorganic microfiber 6 µm  
**A10** Inorganic microfiber 10 µm  
**A16** Inorganic microfiber 16 µm  
**A25** Inorganic microfiber 25 µm

Element Δp	Valves				Execution
	S	B	T	D	
<b>R</b> 20 bar	-	•	-	•	<b>P01</b> MP Filtri standard
<b>S</b> 210 bar	•	-	•	-	<b>Pxx</b> Customized
<b>U</b> 210 bar, stainless steel filter element	•	•	•	•	

### FILTER ELEMENT

Element series and size **HP039** Configuration example: **HP039** **2** **A06** **A** **S** **P01**

Element length **2** | **3** | **4** |

Filtration rating (filter media)  
**A03** Inorganic microfiber 3 µm  
**A06** Inorganic microfiber 6 µm  
**A10** Inorganic microfiber 10 µm  
**A16** Inorganic microfiber 16 µm  
**A25** Inorganic microfiber 25 µm

Seals	Element Δp	Execution
<b>A</b> NBR	<b>R</b> 20 bar	<b>P01</b> MP Filtri standard
<b>V</b> FPM	<b>S</b> 210 bar	<b>Pxx</b> Customized
<b>F</b> MFQ	<b>U</b> 210 bar, stainless steel filter element	

### CLOGGING INDICATORS

See page 687

<b>DEX</b> Electrical differential indicator	<b>DVY</b> Visual differential indicator
<b>DLX</b> Electrical / visual differential indicator	<b>X2</b> Plug
<b>DVX</b> Visual differential indicator	

FZB039	
Filter length	H [mm]
2	190
3	233
4	277

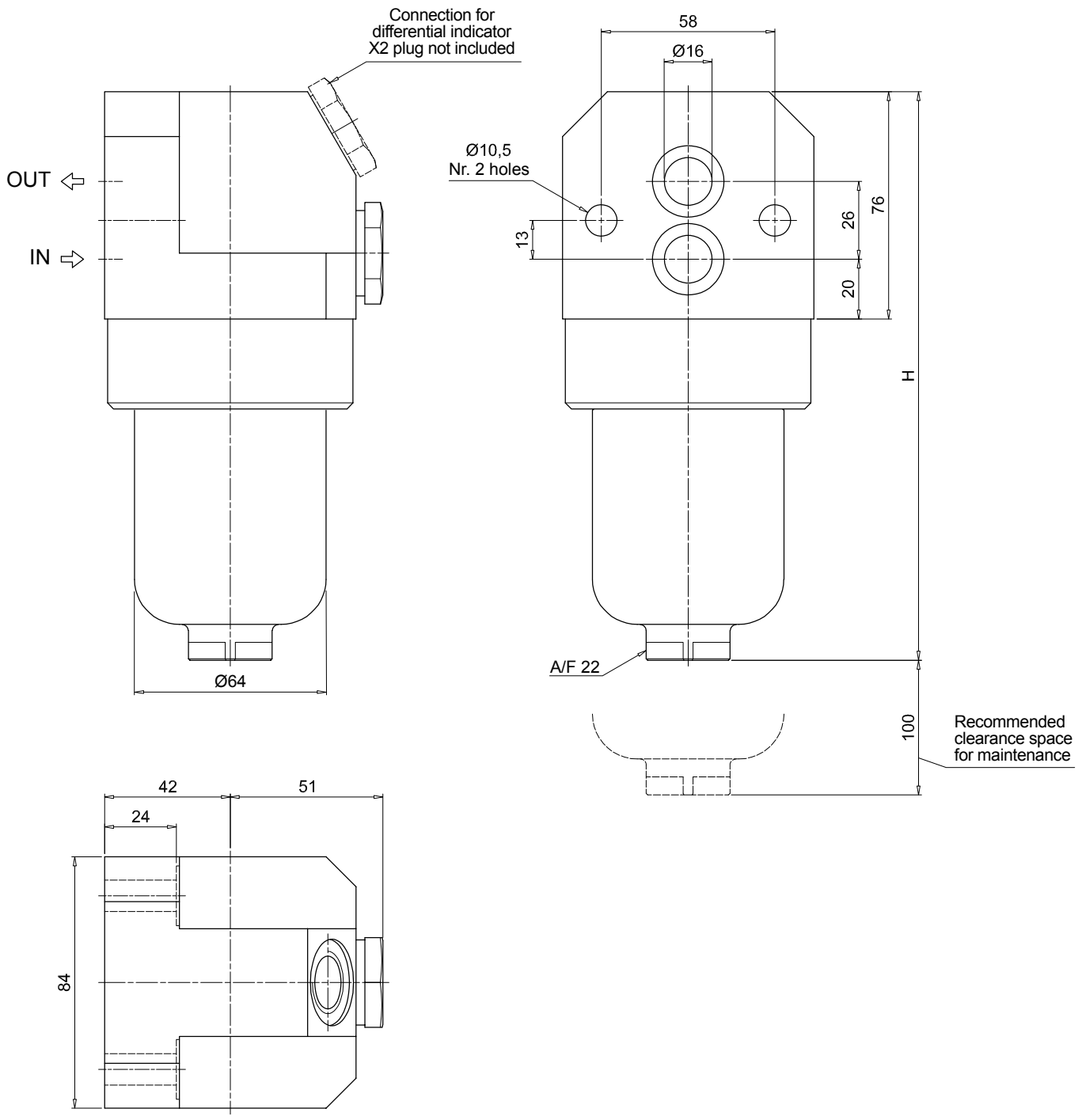

# FZB SPARE PARTS

Order number for spare parts

## FZB 039

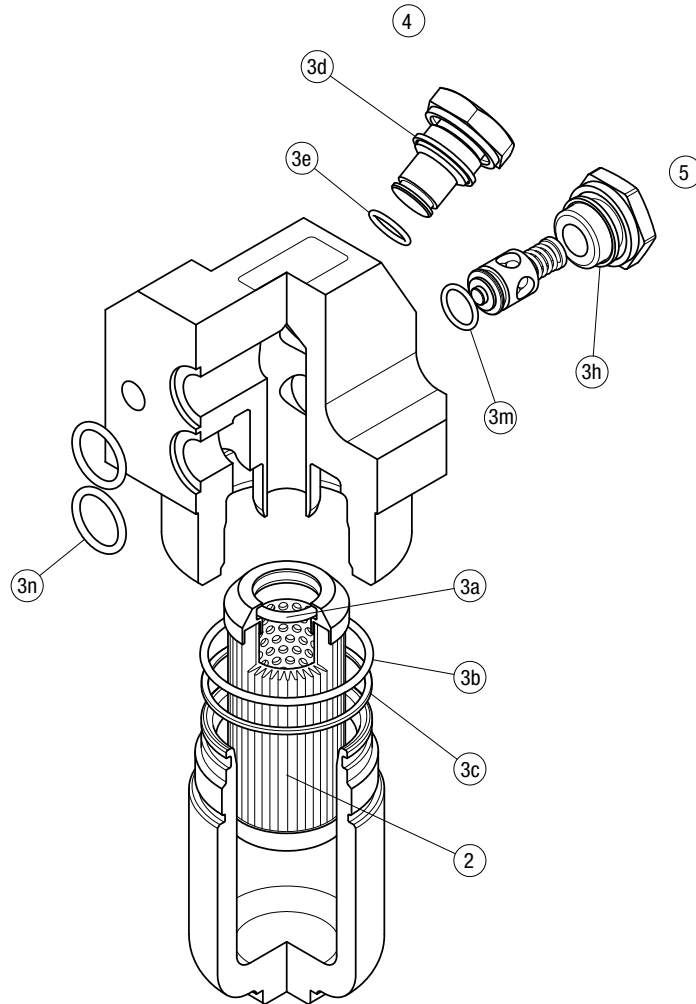

Item:		Seal Kit code number		Indicator connection plug		Bypass assembly / plug	
Filter series	Filter element	NBR	FPM	NBR	FPM	NBR	FPM
<b>FZB 039</b>	See order table	02050647	02050648	X2H	X2V	02001286	02001295



# Clogging indicators

## Introduction

Filter elements are efficient only if their Dirt Holding Capacity is fully exploited. This is achieved by using filter housings equipped with clogging indicators.

These devices trip when the clogging of the filter element causes an increase in pressure drop across the filter element.

The indicator is set to alarm before the element becomes fully clogged.

MP Filtri can supply indicators of the following designs:

- Vacuum switches and gauges
- Pressure switches and gauges
- Differential pressure indicators

These type of devices can be provided with a visual, electrical or both signals.

## Suitable indicator types

### DIFFERENTIAL INDICATORS

Differential indicators are used on the Pressure line to check the efficiency of the filter element. They measure the pressure upstream and downstream of the filter element (differential pressure). Standard items are produced with special connection G 1/2" size. Also available in Stainless Steel models.

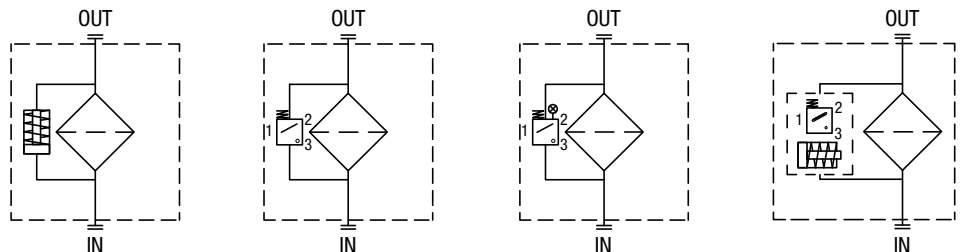

## Quick reference guide

Filter family	Filter series	Visual indicators	Electrical indicators	Electrical / Visual indicators
STAINLESS STEEL HIGH PRESSURE FILTERS	With bypass valve 6 bar	FZH 012 - 040	DVZ50xP01	DEZ50xA50P01
	Without bypass valve	FZH 012 - 040	DVZ70xP01 DVZ95xP01	DEZ70xA50P01 DEZ95xA50P01
	With bypass valve 6 bar	FZP 039 - 136 FZB 039 FZM 039 FZD 051	DVX50xP01 DVY50xP01	DEX50xA50P01 DLX50xA51P01 DLX50xA52P01
	Without bypass valve	FZP 039 - 136 FZB 039 FZM 039 FZD 010 - 021 - 051	DVX70xP01 DVX95xP01 DVY70xP01 DVY95xP01	DEX70xA50P01 DEX95xA50P01 DLX70xA51P01 DLX70xA52P01 DLX95xA51P01 DLX95xA52P01





# DIFFERENTIAL INDICATORS

## Dimensions

DVZ		Hydraulic symbol	<b>Materials</b> - Body: AISI 316L - Internal parts: AISI 316L - Polyamide - Contacts: Silver - Seal: HNBR - MFQ  <b>Technical data</b> - Reset: Automatic reset - Max working pressure: 700 bar - Proof pressure: 1050 bar - Burst pressure: 2100 bar - Working temperature: From -25 °C to +110 °C - Compatibility with fluids: Mineral oils, Synthetic fluids HFA, HFB, HFC according to ISO 2943 - Degree protection: IP65 according to EN 60529
<b>Visual Differential Indicator</b>			
Settings	Ordering code		
5.0 bar ±10%	DV Z 50 x P01		
7.0 bar ±10%	DV Z 70 x P01		
9.5 bar ±10%	DV Z 95 x P01		

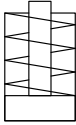
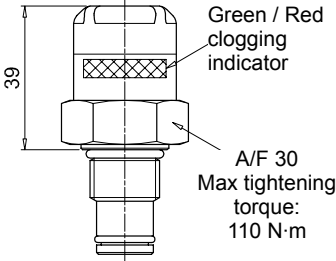
X2		<b>Materials</b> - Body: AISI 316L - Seal: HNBR / MFQ
<b>Indicator plug 420 bar</b>		
Seal	Ordering code	
HNBR	X2 H	
MFQ	X2 F	

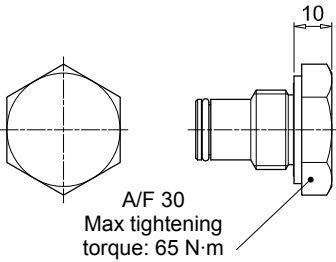

X3		<b>Materials</b> - Body: AISI 316L - Seal: HNBR / MFQ
<b>Indicator plug 700 bar (only for FZH)</b>		
Seal	Ordering code	
HNBR	X3 H	
MFQ	X3 F	

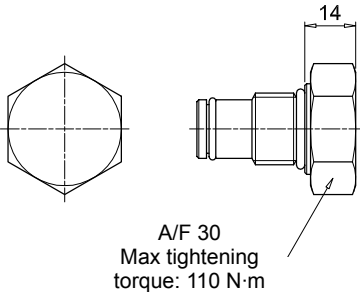

### DESIGNATION & ORDERING CODE - DIFFERENTIAL INDICATORS

Series					Configuration example 1:									
<b>DE</b> Electrical differential indicator					DE	Z	50	H	A	50	P01			
<b>DL</b> Electrical / Visual differential indicator					Configuration example 2:									
<b>DV</b> Visual differential indicator					DL	X	70	V	A	52	P01			
Type					DE	DL	DV							
<b>X</b>	Standard type				•	•	•							
<b>Z</b>	700 bar				•	•	•							
<b>Y</b>	Optional type				-	-	•							
Pressure setting														
<b>50</b>	5.0 bar													
<b>70</b>	7.0 bar													
<b>95</b>	9.5 bar													
Seals														
<b>H</b>	HNBR													
<b>V</b>	FPM													
Thermostat														
<b>A</b>	Without thermostat													
Electrical connections					DEX	DEZ	DL	DV						
<b>48</b>	Connection via three-core cable - fitting M20x1.5				-	-	-	-						
<b>49</b>	Connection via four-core cable - fitting 1/2" NPT				-	-	-	-						
<b>50</b>	Connection EN 175301-803				•	•	-	-						
<b>51</b>	Connection EN 175301-803, transparent base with lamps 24 Vdc				-	-	•	-						
<b>52</b>	Connection EN 175301-803, transparent base with lamps 110 Vdc				-	-	•	-						
<b>70</b>	Connection IEC 61076-2-101 D (M12)				-	-	-	-						

Option	
<b>P01</b>	MP Filtri standard
<b>Pxx</b>	Customized

### DESIGNATION & ORDERING CODE - DIFFERENTIAL INDICATOR PLUG

Series		Configuration example	
<b>X2</b>	Indicator plug 420 bar	X2	H
<b>X3</b>	Indicator plug 700 bar (only for FZH)		
Seals			
<b>H</b>	HNBR		
<b>V</b>	FPM		
<b>F</b>	MFQ		