

LMP 210-211

Maximum working pressure up to 6 MPa (60 bar) - Flow rate up to 365 l/min



TYPICAL FILTER SIZING Selection Software

Step ①

Select "FILTER SIZING SOFTWARE" after login

OR

Select "FILTER SIZING" after login from a product page

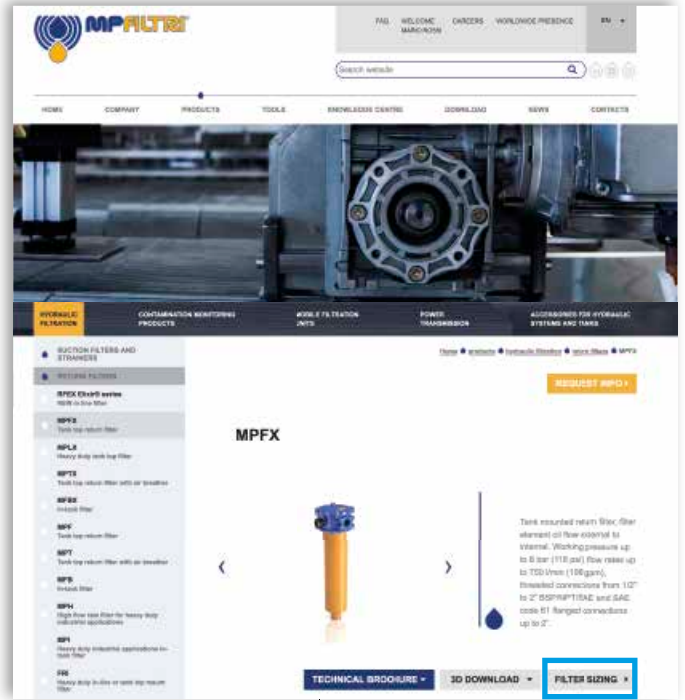

Choose the type of filter family.
Enter the main data for sizing the filter
then push CALCULATE.

Step ②

Enter the main data for sizing the filter
then push CALCULATE.

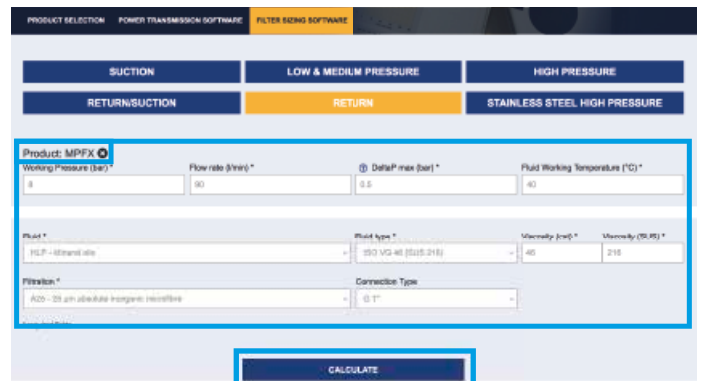
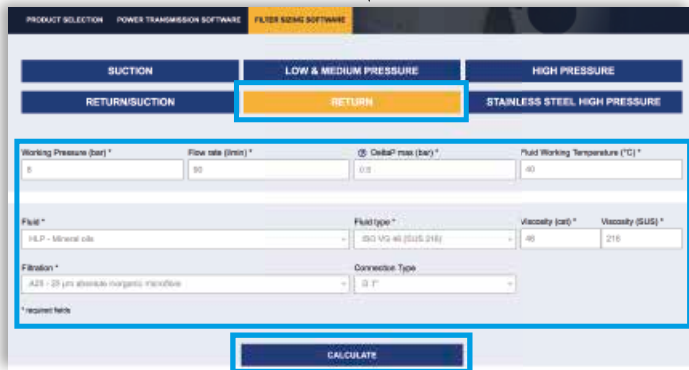

Step ③

Select the desired options to choose the appropriate filter type for the application.

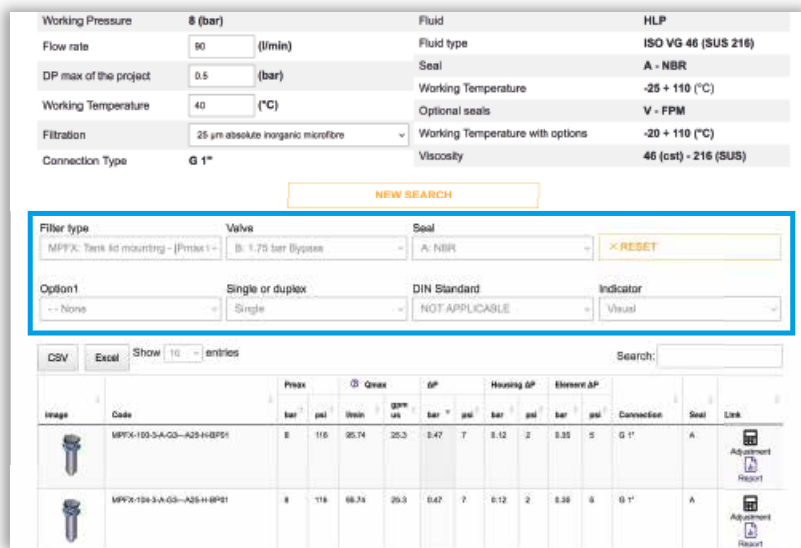

Step 4

Choose the most suitable filter from the proposed list.

Image	Code	Peak bar	Qmax gpm	ΔP bar	Housing ΔP bar	Element ΔP bar	Connection	Seal	Link					
	MPFX-103-3-A-Q3-A25-H-BPFI	8	116	25.74	25.3	0.47	T	0.12	2	0.33	5	G 1"	A	Adjustment Report
	MPFX-104-3-A-Q3-A25-H-BPFI	8	116	25.74	25.3	0.47	T	0.12	2	0.33	5	G 1"	A	Adjustment Report

Step 5

It is possible to change the filter modifying every parameter.

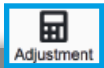

A SAVE YOUR FILTER'S REPORT



B MANUAL EDIT



SAVE IN YOUR ARCHIVE
typing your reference data and then SAVE AS PDF



A new browser window displays the pdf

see A

Close the report window



By clicking your WELCOME button, the SHOW REPORTS is displayed: select it to see your filters list.

LMP 210-211 GENERAL INFORMATION

Description

Technical data

Low & Medium Pressure filters

Maximum working pressure up to 6 MPa (60 bar)
Flow rate up to 365 l/min

LMP210 is a range of versatile low pressure filter for transmission, protection of sensitive components in low pressure hydraulic systems and filtration of the coolant into the machine tools.

They are also suitable for the off-line filtration of small reservoirs. They are directly connected to the lines of the system through the hydraulic fittings.

Available features:

- Flanged connections up to 1 1/2", for a maximum flow rate of 365 l/min (LMP210)
- Female threaded connections up to 1 1/2", for a maximum return flow rate of 365 l/min (LMP211)
- Fine filtration rating, to get a good cleanliness level into the system
- Water removal elements, to remove the free water from the hydraulic fluid. For further information, see the Contamination Management document and the dedicate leaflet.
- Bypass valve, to relieve excessive pressure drop across the filter media
- Visual, electrical and electronic differential clogging indicators

Common applications:

Delivery lines, in any low pressure industrial equipment or mobile machines

Filter housing materials

- Head: Aluminium
- Bowl: Cataphoretic painted steel
- Bypass valve: AISI 304 - Polyamide

Pressure

- Test pressure: 9 MPa (90 bar)
- Burst pressure: 21 MPa (210 bar)
- Pulse pressure fatigue test: 1 000 000 cycles with pressure from 0 to 6 MPa (60 bar)

Bypass valve

- Opening pressure 350 kPa (3.5 bar) ±10%
- Other opening pressures on request.

Δp element type

- Microfibre filter elements - series N: 20 bar
- Fluid flow through the filter element from OUT to IN

Seals

- Standard NBR series A
- Optional FPM series V

Temperature

From -25 °C to +110 °C

Connections

Inlet/Outlet In-Line

Note

LMP 210 - 211 filters are provided for vertical mounting

Weights [kg] and volumes [dm³]

Filter series	Weights [kg]			Volumes [dm ³]				
	Length	1	2	3	Length	1	2	3
LMP 210-211		3.10	4.80	6.40		1.60	2.10	2.80

Filter series	Length	Filter element design - N Series									
		A03	A06	A10	A16	A25	M25	M60	M90	P10	P25
LMP 210	1	106	130	190	200	221	286	287	287	261	265
	2	153	175	220	237	249	288	289	290	265	269
	3	204	214	248	260	265	289	290	291	277	281
LMP 211	1	118	149	227	240	269	358	359	360	324	330
	2	178	207	268	292	307	361	362	363	329	335
	3	247	260	306	323	329	362	363	364	345	351

Maximum flow rate for a complete low and medium pressure filter with a pressure drop $\Delta p = 0.7$ bar.

The reference fluid has a kinematic viscosity of 30 mm²/s (cSt) and a density of 0.86 kg/dm³.

For different pressure drop or fluid viscosity we recommend to use our selection software available on www.mpfiltri.com.

You can also calculate the right size using the formulas present on the FILTER SIZING paragraph at the beginning of the full catalogue or at the beginning of the filter family brochure. Please, contact our Sales Department for further additional information.

Hydraulic symbols

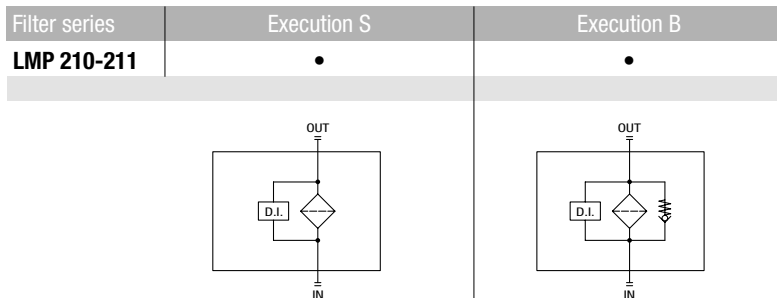

Pressure drop

Filter housings
 Δp pressure drop

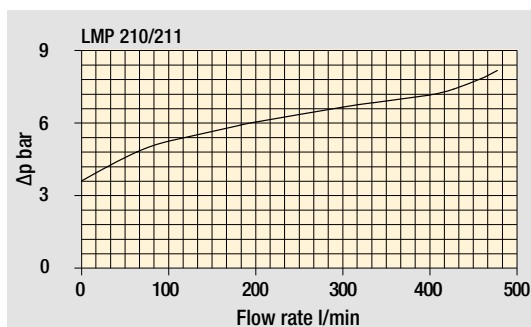
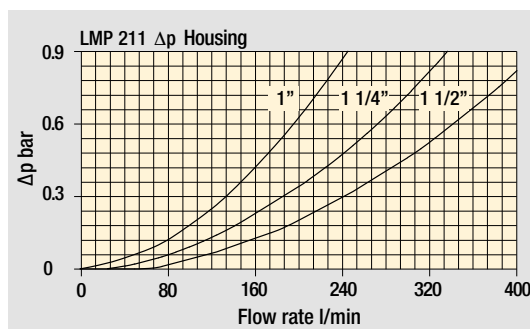
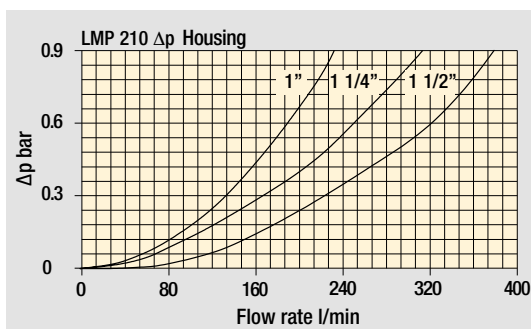

Bypass valve
pressure drop

The curves are plotted using mineral oil with density of 0.86 kg/dm³ in compliance with ISO 3968. Δp varies proportionally with density.

LMP 210

Designation & Ordering code

COMPLETE FILTER

Configuration example: **LMP210** **3** **B** **A** **F1** **A10** **N** **P01**

Series and size
LMP210

Length
1 | **2** | **3**

Bypass valve
S Without bypass | **B** With bypass 3.5 bar

Seals and treatments
A NBR
V FPM

Connections
F1 1" SAE 3000 psi/M
F2 1 1/4" SAE 3000 psi/M
F3 1 1/2" SAE 3000 psi/M
F4 1" SAE 3000 psi/UNC
F5 1 1/4" SAE 3000 psi/UNC
F6 1 1/2" SAE 3000 psi/UNC

Filtration rating (filter media)
A03 Inorganic microfiber 3 µm | **M25** Wire mesh 25 µm
A06 Inorganic microfiber 6 µm | **M60** Wire mesh 60 µm
A10 Inorganic microfiber 10 µm | **M90** Wire mesh 90 µm
A16 Inorganic microfiber 16 µm | **P10** Resin impregnated paper 10 µm
A25 Inorganic microfiber 25 µm | **P25** Resin impregnated paper 25 µm
WA025 Water absorber inorganic microfiber 25 µm

Element Δp
N 20 bar

Execution
P01 MP Filtri standard
Pxx Customized

FILTER ELEMENT

Configuration example: **CU210** **3** **A10** **A** **N** **P01**

Element series and size
CU210

Element length
1 | **2** | **3**

Filtration rating (filter media)
A03 Inorganic microfiber 3 µm | **M25** Wire mesh 25 µm
A06 Inorganic microfiber 6 µm | **M60** Wire mesh 60 µm
A10 Inorganic microfiber 10 µm | **M90** Wire mesh 90 µm
A16 Inorganic microfiber 16 µm | **P10** Resin impregnated paper 10 µm
A25 Inorganic microfiber 25 µm | **P25** Resin impregnated paper 25 µm
WA025 Water absorber inorganic microfiber 25 µm

Seals and treatments
A NBR
V FPM

Element Δp
N 20 bar

Execution
P01 MP Filtri standard
Pxx Customized

CLOGGING INDICATORS

See page 478

DEA Electrical differential indicator	DTA Electronic differential indicator
DEM Electrical differential indicator	DVA Visual differential indicator
DLA Electrical / visual differential indicator	DVM Visual differential indicator
DLE Electrical / visual differential indicator	T2 Plug

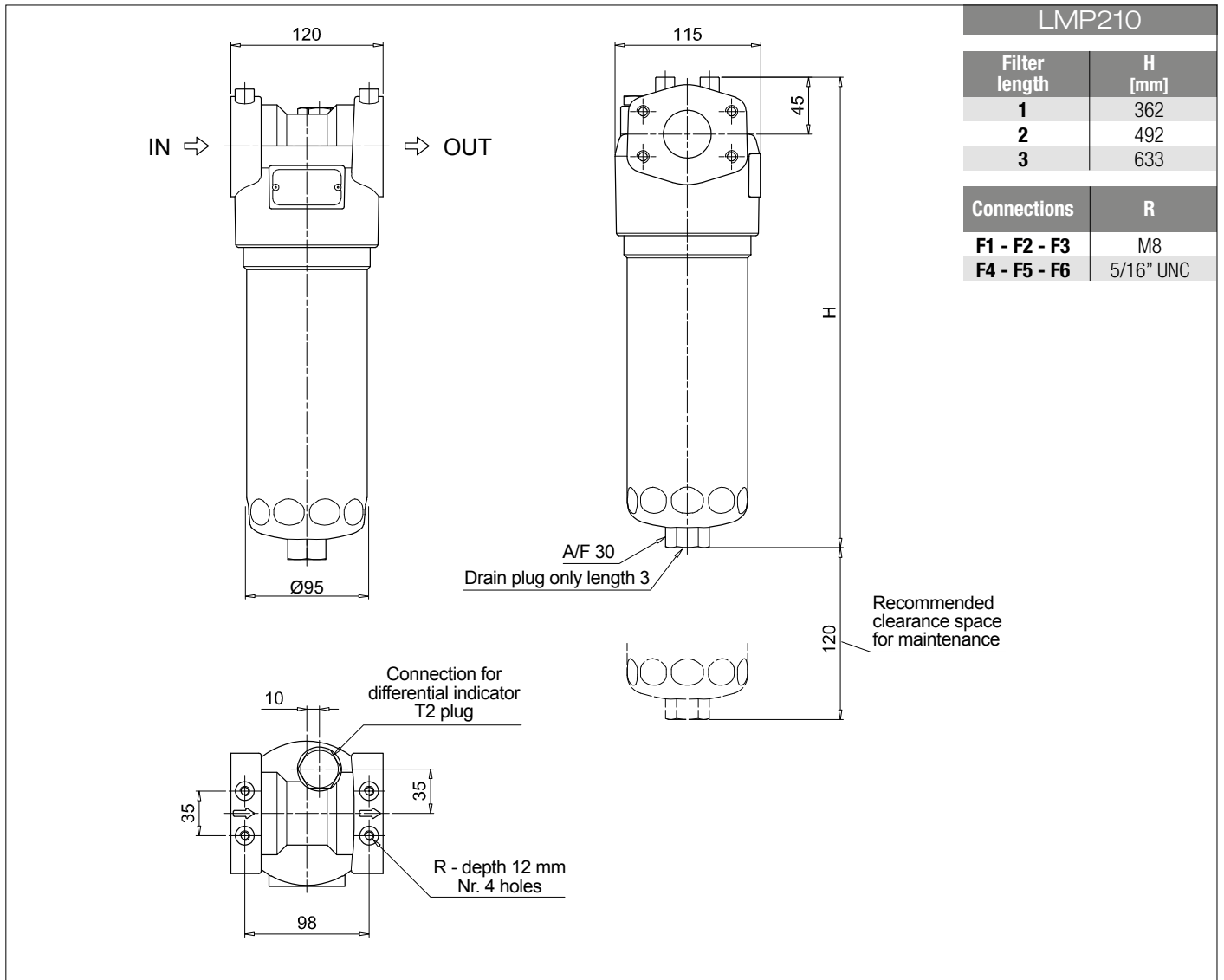

LMP 211

Designation & Ordering code

COMPLETE FILTER

Series and size **LMP211** Configuration example: **LMP211** | **3** | **B** | **A** | **D** | **6** | **A10** | **N** | **P01**

Length
1 | **2** | **3**

Bypass valve
S Without bypass | **B** With bypass 3.5 bar

Seals and treatments
A NBR
V FPM

Connections
A G 1"
B G 1 1/4"
C G 1 1/2"
D 1" NPT
E 1 1/4" NPT
F 1 1/2" NPT
G SAE 16 - 1 5/16" - 12 UN
H SAE 20 - 1 5/8" - 12 UN
I SAE 24 - 1 7/8" - 12 UN

Connection for differential indicator
6 With plugged connection

Filtration rating (filter media)
A03 Inorganic microfiber 3 µm | **M25** Wire mesh 25 µm
A06 Inorganic microfiber 6 µm | **M60** Wire mesh 60 µm
A10 Inorganic microfiber 10 µm | **M90** Wire mesh 90 µm
A16 Inorganic microfiber 16 µm | **P10** Resin impregnated paper 10 µm
A25 Inorganic microfiber 25 µm | **P25** Resin impregnated paper 25 µm
WA025 Water absorber inorganic microfiber 25 µm

Element Δp
N 20 bar

Execution
P01 MP Filtri standard
Pxx Customized

FILTER ELEMENT

Element series and size **CU210** Configuration example: **CU210** | **3** | **A10** | **A** | **N** | **P01**

Element length
1 | **2** | **3**

Filtration rating (filter media)
A03 Inorganic microfiber 3 µm | **M25** Wire mesh 25 µm
A06 Inorganic microfiber 6 µm | **M60** Wire mesh 60 µm
A10 Inorganic microfiber 10 µm | **M90** Wire mesh 90 µm
A16 Inorganic microfiber 16 µm | **P10** Resin impregnated paper 10 µm
A25 Inorganic microfiber 25 µm | **P25** Resin impregnated paper 25 µm
WA025 Water absorber inorganic microfiber 25 µm

Seals and treatments
A NBR
V FPM

Element Δp
N 20 bar

Execution
P01 MP Filtri standard
Pxx Customized

CLOGGING INDICATORS

See page 478

DEA Electrical differential indicator
DEM Electrical differential indicator
DLA Electrical / visual differential indicator
DLE Electrical / visual differential indicator

DTA Electronic differential indicator
DVA Visual differential indicator
DVM Visual differential indicator
T2 Plug

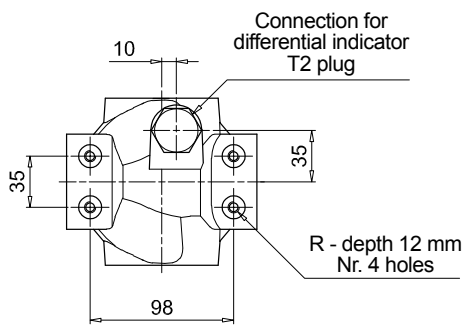
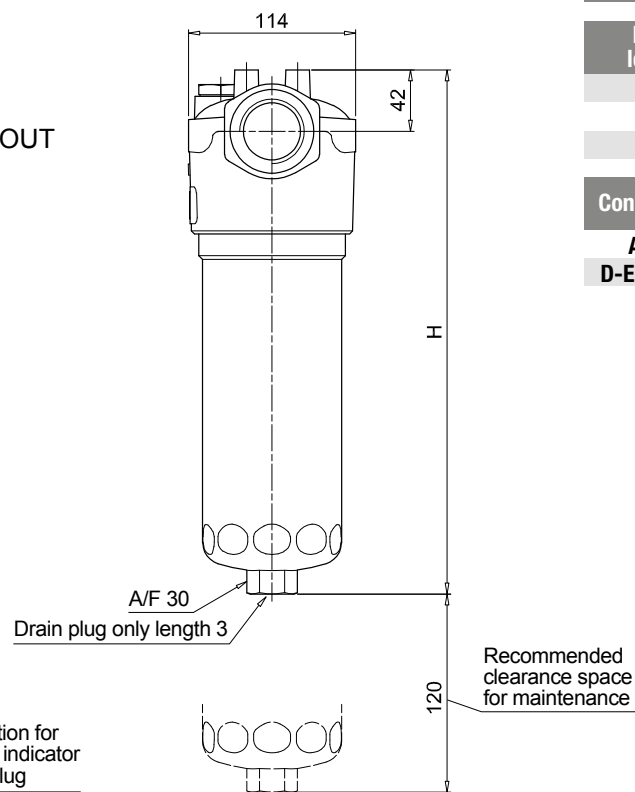
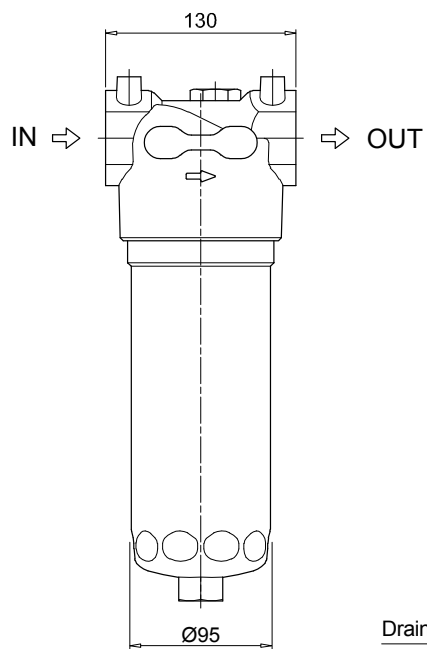

LMP211	
Filter length	H [mm]
1	358
2	488
3	629
Connections	R
A-B-C	M8
D-E-F-G-H-I	5/16" UNC

LMP 210-211 SPARE PARTS

Order number for spare parts

LMP 210

LMP 211

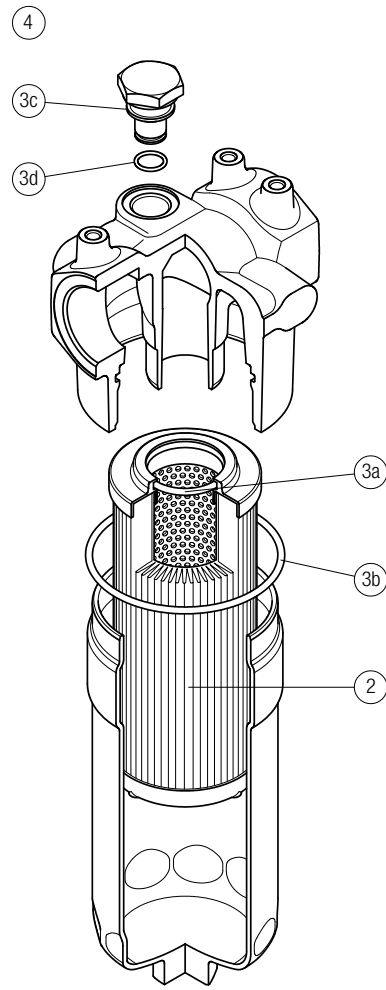
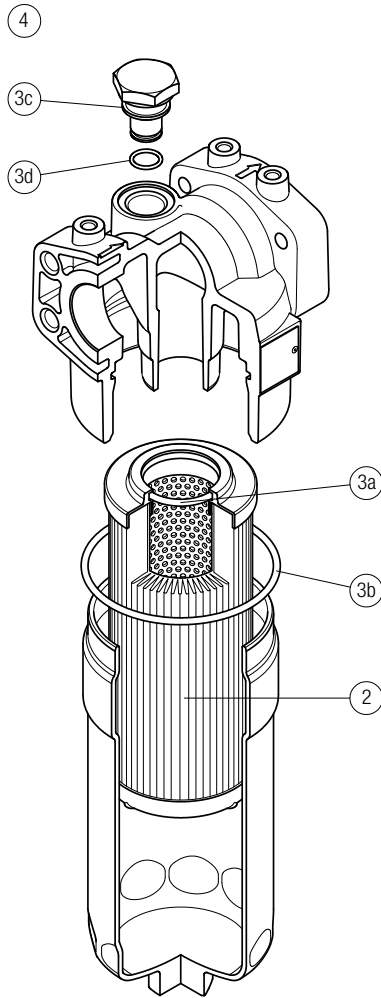

Item:	Q.ty: 1 pc.		Q.ty: 1 pc.		Q.ty: 1 pc.	
Filter series	Filter element	Seal Kit code number		Indicator connection plug		
LMP 210-211	See order table	NBR	FPM	NBR	FPM	
	2	02050435	02050436	T2H	T2V	
		3 (3a ÷ 3d)		4		

Clogging indicators

Introduction

Filter elements are efficient only if their Dirt Holding Capacity is fully exploited. This is achieved by using filter housings equipped with clogging indicators.

These devices trip when the clogging of the filter element causes an increase in pressure drop across the filter element.

The indicator is set to alarm before the element becomes fully clogged.

MP Filtri can supply indicators of the following designs:

- Vacuum switches and gauges
- Pressure switches and gauges
- Differential pressure indicators

These type of devices can be provided with a visual, electrical or both signals.

Suitable indicator types

DIFFERENTIAL INDICATORS

Differential indicators are used on the Pressure line to check the efficiency of the filter element. They measure the pressure upstream and downstream of the filter element (differential pressure).

Standard items are produced with special connection G 1/2" size.

Also available in Stainless Steel models.

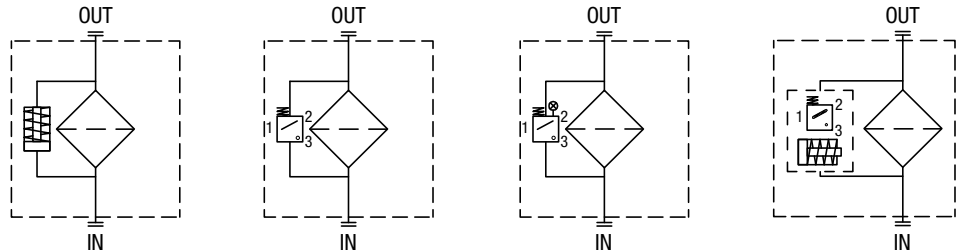

Quick reference guide

Filter family	Filter series	Visual indicators	Electrical indicators	Electrical / Visual indicators
LOW & MEDIUM PRESSURE FILTERS	ELIXIR® LFEX060-080-110-160	DVS25HP01	DES25HA10P01 DES25HA30P01 DES25HA80P01	
	With bypass valve 3.5 bar LMP 110 - 112 - 116 - 118 - 119 MULTIPORT LMP 120 - 122 - 123 MULTIPORT LMP 210 - 211 - LDP LMP 400 - 401 & 430 - 431 LMP 900 - 901 LMP 902 - 903 LMP 950 - 951 LMP 952 - 953 - 954 LMD 211 - 400 - 401 - 431 - 951 - LDD	DVA20xP01 DVM20xP01	DEA20xA50P01 DEM20XX10P01 DEM20XX20P01 DEM20XX30P01 DEM20XX35P01 DTA20xF70P01	DLA20xA51P01 DLA20xA52P01 DLA20xA71P01 DLE20xA50P01 DLE20xF50P01
	ELIXIR® LFEX060-080-110-160	DVS40HP01	DES40HA10P01 DES40HA30P01 DES40HA80P01	
	Without bypass valve LMP 110 - 112 - 116 - 118 - 119 MULTIPORT LMP 120 - 122 - 123 MULTIPORT LMP 210 - 211 - LDP LMP 400 - 401 & 430 - 431 LMP 900 - 901 LMP 902 - 903 LMP 950 - 951 LMP 952 - 953 - 954 LMD 211 - 400 - 401 - 431 - 951 - LDD	DVA50xP01 DVM50xP01	DEA50xA50P01 DEM50XX10P01 DEM50XX20P01 DEM50XX30P01 DEM50XX35P01 DTA50xF70P01	DLA50xA51P01 DLA50xA52P01 DLA50xA71P01 DLE50xA50P01 DLE50xF50P01

DEA*50	
Electrical Differential Indicator	
Settings	Ordering code
2.0 bar $\pm 10\%$	DE A 20 x A 50 P01
5.0 bar $\pm 10\%$	DE A 50 x A 50 P01

Hydraulic symbol

Electrical symbol

Materials

- Body: Brass
- Base: Black polyamide
- Contacts: Silver
- Seal: HNBR - FPM

Technical data

- Max working pressure: 420 bar
- Proof pressure: 630 bar
- Burst pressure: 1260 bar
- Working temperature: From -25 °C to +110 °C
- Compatibility with fluids: Mineral oils, Synthetic fluids
HFA, HFB, HFC according to ISO 2943
- Degree protection: IP66 according to EN 60529
IP69K according to ISO 20653

Electrical data

- Electrical connection: EN 175301-803
- Resistive load: 0.2 A / 115 Vdc

DEM*10	
Electrical Differential Indicator	
Settings	Ordering code
2.0 bar $\pm 10\%$	DE M 20 x x 10 P01
5.0 bar $\pm 10\%$	DE M 50 x x 10 P01

Hydraulic symbol

Electrical symbol

Materials

- Body: Brass
- Base: Black polyamide
- Contacts: Silver
- Seal: HNBR - FPM

Technical data

- Max working pressure: 420 bar
- Proof pressure: 630 bar
- Burst pressure: 1260 bar
- Working temperature: From -25 °C to +110 °C
- Compatibility with fluids: Mineral oils, Synthetic fluids
HFA, HFB, HFC according to ISO 2943
- Degree protection: IP66 according to EN 60529

Electrical data

- Electrical connection: AMP Superseal series 1.5
- Resistive load: 0.2 A / 115 Vdc
- Switching type: Normally open contacts (NC on request)
- Thermal lockout: Normally open up to 30 °C (option "F")

DEM*20	
Electrical Differential Indicator	
Settings	Ordering code
2.0 bar $\pm 10\%$	DE M 20 x x 20 P01
5.0 bar $\pm 10\%$	DE M 50 x x 20 P01

Hydraulic symbol

Electrical symbol

Materials

- Body: Brass
- Base: Black polyamide
- Contacts: Silver
- Seal: HNBR - FPM

Technical data

- Max working pressure: 420 bar
- Proof pressure: 630 bar
- Burst pressure: 1260 bar
- Working temperature: From -25 °C to +110 °C
- Compatibility with fluids: Mineral oils, Synthetic fluids
HFA, HFB, HFC according to ISO 2943
- Degree protection: IP66 according to EN 60529

Electrical data

- Electrical connection: AMP Time junior
- Resistive load: 0.2 A / 115 Vdc
- Switching type: Normally open contacts (NC on request)
- Thermal lockout: Normally open up to 30 °C (option "F")

DIFFERENTIAL INDICATORS

Dimensions

DEM*30	
Electrical Differential Indicator	
Settings	Ordering code
2.0 bar $\pm 10\%$	DE M 20 x x 30 P01
5.0 bar $\pm 10\%$	DE M 50 x x 30 P01

A/F 28
Max tightening torque: 65 N·m

Hydraulic symbol

Electrical symbol

Materials

- Body: Brass
- Base: Black polyamide
- Contacts: Silver
- Seal: HNBR - FPM

Technical data

- Max working pressure: 420 bar
- Proof pressure: 630 bar
- Burst pressure: 1260 bar
- Working temperature: From -25 °C to +110 °C
- Compatibility with fluids: Mineral oils, Synthetic fluids
HFA, HFB, HFC according to ISO 2943
- Degree protection: IP66 according to EN 60529

Electrical data

- Electrical connection: Deutsch DT-04-2-P
- Resistive load: 0.2 A / 115 Vdc
- Switching type: Normally open contacts (NC on request)
- Thermal lockout: Normally open up to 30 °C (option "F")

DEM*35	
Electrical Differential Indicator	
Settings	Ordering code
2.0 bar $\pm 10\%$	DE M 20 x x 35 P01
5.0 bar $\pm 10\%$	DE M 50 x x 35 P01

A/F 28
Max tightening torque: 65 N·m

Hydraulic symbol

Electrical symbol

Materials

- Body: Brass
- Base: Black polyamide
- Contacts: Silver
- Seal: HNBR - FPM

Technical data

- Max working pressure: 420 bar
- Proof pressure: 630 bar
- Burst pressure: 1260 bar
- Working temperature: From -25 °C to +110 °C
- Compatibility with fluids: Mineral oils, Synthetic fluids
HFA, HFB, HFC according to ISO 2943
- Degree protection: IP66 according to EN 60529

Electrical data

- Electrical connection: Deutsch DT-04-3-P
- Resistive load: 0.2 A / 115 Vdc
- Switching type: SPDT contact
- Thermal lockout: Normally open up to 30 °C (option "F")

DES*10	
Electrical Differential Indicator	
Settings	Ordering code
2.5 bar $\pm 10\%$	DE S 25 HA 10 P01
4.0 bar $\pm 10\%$	DE S 40 HA 10 P01

A/F 19
Max tightening torque: 25 N·m

Hydraulic symbol

Electrical symbol

Materials

- Body: Brass
- Internal parts: Brass - Polyamide
- Contacts: Silver
- Seal: HNBR

Technical data

- Max working pressure: 16 bar
- Proof pressure: 24 bar
- Burst pressure: 48 bar
- Working temperature: From -25 °C to +110 °C
- Compatibility with fluids: Mineral oils, Synthetic fluids
HFA, HFB, HFC according to ISO 2943
- Degree protection: IP67 according to EN 60529

Electrical data

- Electrical connection: AMP Superseal series 1.5
- Resistive load: 0.2 A / 24 Vdc
- Switching type: Normally open contacts (NC on request)

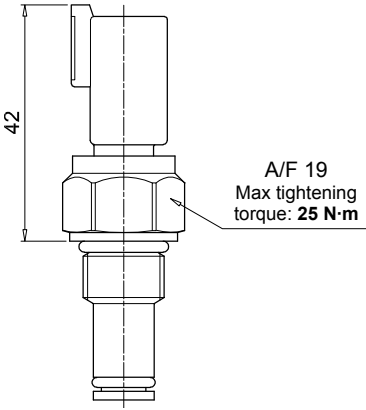
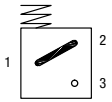
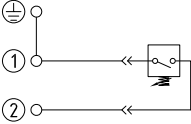
DES*30	
Electrical Differential Indicator	
Settings	Ordering code
2.5 bar $\pm 10\%$	DE S 25 H A 30 P01
4.0 bar $\pm 10\%$	DE S 40 H A 30 P01
	
Hydraulic symbol 	
Electrical symbol 	
Materials - Body: Brass - Internal parts: Brass - Polyamide - Contacts: Silver - Seal: HNBR	
Technical data - Max working pressure: 16 bar - Proof pressure: 24 bar - Burst pressure: 48 bar - Working temperature: From -25 °C to +110 °C - Compatibility with fluids: Mineral oils, Synthetic fluids HFA, HFB, HFC according to ISO 2943 - Degree protection: IP67 according to EN 60529	
Electrical data - Electrical connection: Deutsch DT-04-2-P - Resistive load: 0.2 A / 24 Vdc - Switching type: Normally open contacts (NC on request)	

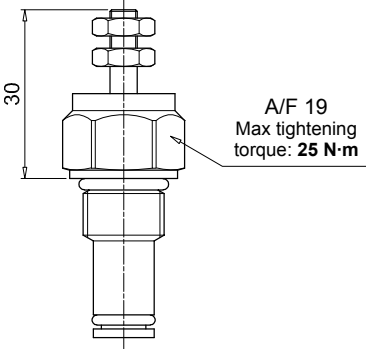
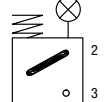
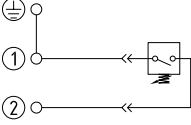
DES*80	
Electrical Differential Indicator	
Settings	Ordering code
2.5 bar $\pm 10\%$	DE S 25 H A 80 P01
4.0 bar $\pm 10\%$	DE S 40 H A 80 P01
	
Hydraulic symbol 	
Electrical symbol 	
Materials - Body: Brass - Internal parts: Brass - Polyamide - Contacts: Silver - Seal: HNBR	
Technical data - Max working pressure: 16 bar - Proof pressure: 24 bar - Burst pressure: 48 bar - Working temperature: From -25 °C to +110 °C - Compatibility with fluids: Mineral oils, Synthetic fluids HFA, HFB, HFC according to ISO 2943 - Degree protection: IP67 according to EN 60529	
Electrical data - Electrical connection: Stud #10-32 UNF - Resistive load: 0.2 A / 24 Vdc - Switching type: Normally open contacts (NC on request)	

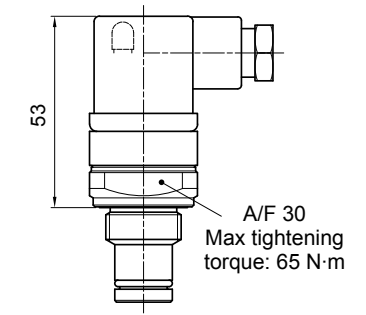
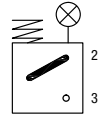
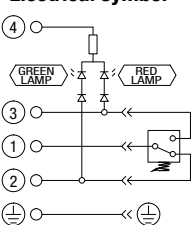
DLA*51 - DLA*52	
Electrical/Visual Differential Indicator	
Settings	Ordering code
2.0 bar $\pm 10\%$	DL A 20 x A x x P01
5.0 bar $\pm 10\%$	DL A 50 x A x x P01
	
Hydraulic symbol 	
Electrical symbol 	
Materials - Body: Brass - Base: Transparent polyamide - Contacts: Silver - Seal: HNBR - FPM	
Technical data - Max working pressure: 420 bar - Proof pressure: 630 bar - Burst pressure: 1260 bar - Working temperature: From -25 °C to +110 °C - Compatibility with fluids: Mineral oils, Synthetic fluids HFA, HFB, HFC according to ISO 2943 - Degree protection: IP66 according to EN 60529 IP69K according to ISO 20653	
Electrical data - Electrical connection: EN 175301-803 - Type: 51 52 - Lamps: 24 Vdc 110 Vdc - Resistive load: 1 A / 24 Vdc 1 A / 110 Vdc	

DIFFERENTIAL INDICATORS

Dimensions

DLA*71	
Electrical/Visual Differential Indicator	
Settings	Ordering code
2.0 bar \pm 10%	DLA 20 x A 71 P01
5.0 bar \pm 10%	DLA 50 x A 71 P01

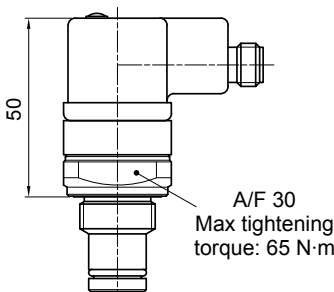

Hydraulic symbol

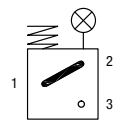

Electrical symbol

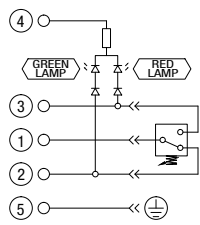

Materials

- Body: Brass
- Base: Black polyamide
- Contacts: Silver
- Seal: HNBR - FPM

Technical data

- Max working pressure: 420 bar
- Proof pressure: 630 bar
- Burst pressure: 1260 bar
- Working temperature: From -25 °C to +110 °C
- Compatibility with fluids: Mineral oils, Synthetic fluids
HFA, HFB, HFC according to ISO 2943
- Degree protection: IP65 according to EN 60529
IP69K according to ISO 20653

Electrical data

- Electrical connection: IEC 61076-2-101 D (M12)
- Lamps: 24 Vdc
- Resistive load: 0.4 A / 24 Vdc

DLE*A50	
Electrical/Visual Differential Indicator	
Settings	Ordering code
2.0 bar \pm 10%	DL E 20 x A 50 P01
5.0 bar \pm 10%	DL E 50 x A 50 P01

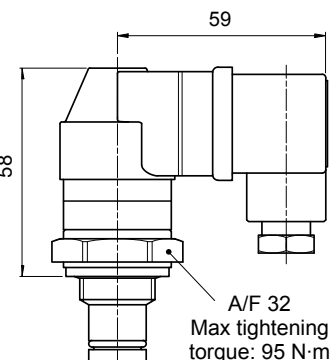

Hydraulic symbol

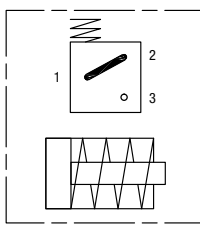

Electrical symbol

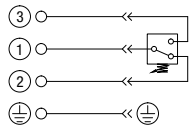

Materials

- Body: Brass
- Base: Black polyamide
- Contacts: Silver
- Seal: HNBR - FPM

Technical data

- Max working pressure: 420 bar
- Proof pressure: 630 bar
- Burst pressure: 1260 bar
- Working temperature: From -25 °C to +110 °C
- Compatibility with fluids: Mineral oils, Synthetic fluids
HFA, HFB, HFC according to ISO 2943
- Degree protection: IP65 according to EN 60529

Electrical data

- Electrical connections: EN 175301-803
- Resistive load: 5 A / 250 Vac
- Available the connector with lamps

DLE*F50	
Electrical/Visual Differential Indicator	
Settings	Ordering code
2.0 bar \pm 10%	DL E 20 x F 50 P01
5.0 bar \pm 10%	DL E 50 x F 50 P01

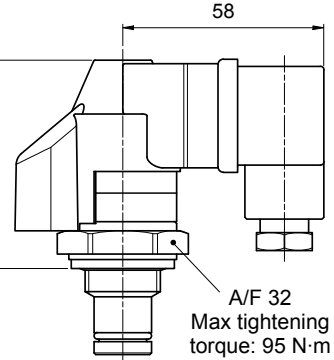

Hydraulic symbol

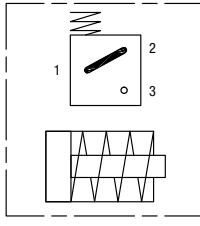

Electrical symbol

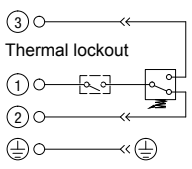

Materials

- Body: Brass
- Base: Black polyamide
- Contacts: Silver
- Seal: HNBR - FPM

Technical data

- Max working pressure: 420 bar
- Proof pressure: 630 bar
- Burst pressure: 1260 bar
- Working temperature: From -25 °C to +110 °C
- Compatibility with fluids: Mineral oils, Synthetic fluids
HFA, HFB, HFC according to ISO 2943
- Degree protection: IP65 according to EN 60529

Electrical data

- Electrical connections: EN 175301-803
- Resistive load: 5 A / 250 Vac
- Thermal lockout setting: +30 °C

DTA*70	
Electronic Differential Indicator	
Settings	Ordering code
2.0 bar \pm 10%	DT A 20 x x 70 P01
5.0 bar \pm 10%	DT A 50 x x 70 P01

47

A/F 30
Max tightening torque: 50 N·m

Hydraulic symbol

Materials

- Body: Brass
- Internal parts: Brass - Polyamide
- Contacts: Silver
- Seal: HNBR - FPM

Technical data

- Max working pressure: 420 bar
- Proof pressure: 630 bar
- Burst pressure: 1260 bar
- Compatibility with fluids: Mineral oils, Synthetic fluids HFA, HFB, HFC according to ISO 2943
- Degree protection: IP67 according to EN 60529

Electrical data

- Electrical connection: IEC 61076-2-101 D (M12)
- Power supply: 24 Vdc
- Analogue output: From 4 to 20 mA
- Thermal lockout: 30 °C (all output signals stalled up to 30 °C)

Electrical symbol

①	○	○	+24 Vdc
②	○	○	4 ÷ 20 mA
③	○	○	75% - N.O. Digital output
④	○	○	100% - N.O. Digital output
⑤	○	○	0 Vdc

DVA	
Visual Differential Indicator	
Settings	Ordering code
2.0 bar \pm 10%	DV A 20 x P01
5.0 bar \pm 10%	DV A 50 x P01

39

Green / Red clogging indicator

A/F 28
Max tightening torque: 65 N·m

Hydraulic symbol

Materials

- Body: Brass
- Internal parts: Brass - Polyamide
- Contacts: Silver
- Seal: HNBR - FPM

Technical data

- Reset: Automatic reset
- Max working pressure: 420 bar
- Proof pressure: 630 bar
- Burst pressure: 1260 bar
- Working temperature: From -25 °C to +110 °C
- Compatibility with fluids: Mineral oils, Synthetic fluids HFA, HFB, HFC according to ISO 2943
- Degree protection: IP65 according to EN 60529

DVM	
Visual Differential Indicator	
Settings	Ordering code
2.0 bar \pm 10%	DV M 20 x P01
5.0 bar \pm 10%	DV M 50 x P01

34

Red clogging indicator

A/F 30
Max tightening torque: 65 N·m

Hydraulic symbol

Materials

- Body: Brass
- Internal parts: Brass - Polyamide
- Contacts: Silver
- Seal: HNBR - FPM

Technical data

- Reset: Manual reset
- Max working pressure: 420 bar
- Proof pressure: 630 bar
- Burst pressure: 1260 bar
- Working temperature: From -25 °C to +110 °C
- Compatibility with fluids: Mineral oils, Synthetic fluids HFA, HFB, HFC according to ISO 2943
- Degree protection: IP65 according to EN 60529

DIFFERENTIAL INDICATORS

Dimensions

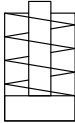
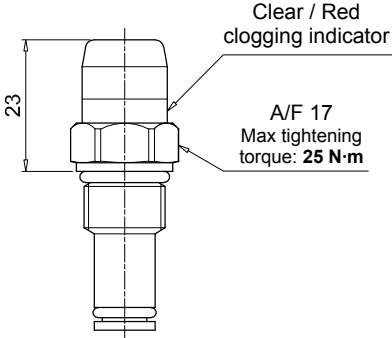
DVS		Hydraulic symbol	Materials
Visual Differential Indicator			
Settings	Ordering code		- Body: Brass - Internal parts: Brass - Polyamide - Contacts: Silver - Seal: HNBR
2.5 bar $\pm 10\%$	DV S 25 H P01		
4.0 bar $\pm 10\%$	DV S 40 H P01		
		Technical data - Reset: Automatic reset - Max working pressure: 16 bar - Proof pressure: 24 bar - Burst pressure: 48 bar - Working temperature: From -25 °C to +110 °C - Compatibility with fluids: Mineral oils, Synthetic fluids HFA, HFB, HFC according to ISO 2943 - Degree protection: IP67 according to EN 60529	

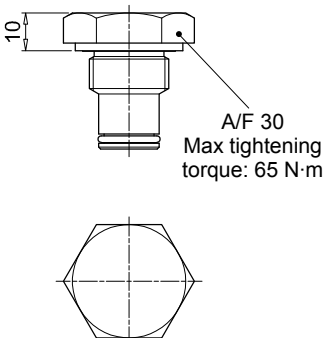
T2		Materials
Indicator plug		
Seal	Ordering code	- Body: Phosphatized steel - Seal: HNBR / FPM
HNBR	T2 H	
FPM	T2 V	
		

DESIGNATION & ORDERING CODE - DIFFERENTIAL INDICATORS										
Series		Configuration example 1:								
DE Electrical differential indicator		DE	M	20	H	F	50	P01		
DL Electrical/Visual differential indicator		Configuration example 2:								
		DL	E	50	V	A	71	P01		
DT Electronic differential indicator		Configuration example 3:								
		DT	A	20	H	F	70	P01		
DV Visual differential indicator		Configuration example 4:								
		DV	M	50	V			P01		
Type	DE	DL	DT	DV						
A Standard type	•	•	•	A With automatic reset						
M With wired electrical connection	•	-	-	M With manual reset						
E For high power supply	-	•	-	S With automatic reset						
S Compact version	•	-	-							
Pressure setting										
20	2.0 bar									
25	2.5 bar									
40	4.0 bar									
50	5.0 bar									
Seals										
H	HNBR									
V	FPM									
Thermostat				DEA	DEM	DLA	DLE	DT	DV	
A	Without			•	•	•	•	-	-	
F	With thermostat			-	•	-	•	•	-	
Electrical connections				DEA	DEM	DLA	DLE	DT	DV	
10	Connection AMP Superseal series 1.5			-	•	-	-	-	-	
20	Connection AMP Timer Junior			-	•	-	-	-	-	
30	Connection Deutsch DT-04-2-P			-	•	-	-	-	-	
35	Connection Deutsch DT-04-3-P			-	•	-	-	-	-	
50	Connection EN 175301-803			•	-	-	•	-	-	
51	Connection EN 175301-803, transparent base with lamps 24 Vdc			-	-	•	-	-	-	
52	Connection EN 175301-803, transparent base with lamps 110 Vdc			-	-	•	-	-	-	
70	Connection IEC 61076-2-101 D (M12)			-	-	-	-	•	-	
71	Connection IEC 61076-2-101 D (M12), black base with lamps 24 Vdc			-	-	•	-	-	-	
Option										
P01	MP Filtri standard									
Pxx	Customized									

DESIGNATION & ORDERING CODE - DIFFERENTIAL INDICATOR PLUG				
Series		Configuration example	T2	H
T2	Indicator plug			
Seals				
H	HNBR			
V	FPM			